

EASTON PARK



Residential Development Guidelines



<b>I. GENERAL.....</b>	<b>5</b>
1.1 COMMUNITY VISION .....	5
1.2 BUILDER RESPONSIBILITY.....	5
1.3 DEFINITIONS.....	5
<b>II. DESIGN .....</b>	<b>8</b>
2.1 ARCHITECTURAL STYLES .....	8
2.2 PLAN REPETITION .....	8
2.3 COLOR & MATERIAL REPETITION.....	8
2.4 LOT DESIGNATIONS.....	9
2.5 GENERAL REQUIREMENTS – (ALL HOMES) .....	9
2.6 URBAN YARD HOME – REQUIREMENTS.....	16
2.7 MOTOR COURT & MINI MOTOR COURT HOME – REQUIREMENTS .....	19
<b>III. FENCING .....</b>	<b>21</b>
3.1 GENERAL .....	21
3.2 FENCE RESPONSIBILITY .....	21
3.3 FENCE TYPES & REQUIREMENTS .....	21
3.4 FENCE LOCATIONS .....	22
3.5 GATES.....	22
3.6 EQUIPMENT SCREENING .....	23
<b>IV. LANDSCAPE.....</b>	<b>24</b>
4.1 LANDSCAPE APPROACH .....	24
4.2 DRAINAGE.....	24
4.3 IRRIGATION .....	24
4.4 SOD.....	24
4.5 LANDSCAPE BEDS .....	24
4.6 PLANT BED EDGING .....	25
4.7 PLANT MATERIAL .....	25
4.8 INSTALLATION.....	25
4.9 GRAVEL & ROCK .....	25
4.10 MAINTENANCE .....	25
4.11 PARKWAY STRIP LANDSCAPE.....	25
4.12 LANDSCAPE USED AS SCREENING .....	26
4.13 URBAN YARD HOME – LANDSCAPE REQUIREMENTS .....	27
4.14 URBAN YARD HOME – REAR YARD LANDSCAPE .....	28
4.15 MOTOR COURT & MINI MOTOR COURT - LANDSCAPE REQUIREMENTS .....	29
4.16 MOTOR COURT & MINI MOTOR COURT - FRONT YARD LANDSCAPE .....	29
4.17 MOTOR COURT & MINI MOTOR COURT - SIDE YARD LANDSCAPE .....	29
4.18 MOTOR COURT & MINI MOTOR COURT - REAR YARD LANDSCAPE .....	30
4.19 MOTOR COURT & MINI MOTOR COURT - COURTYARD LANDSCAPE .....	30
<b>V. PROCEDURES &amp; SUBMISSIONS (FOR BUILDERS DURING INITIAL HOME CONSTRUCTION.) .....</b>	<b>31</b>
5.1 GENERAL .....	31
5.2 PROCEDURE .....	31
5.3 REQUIRED SUBMISSION INFORMATION .....	31
5.4 QUALITY OF SUBMISSION CONTENT .....	32
5.5 SUBMISSION TIMING.....	32
5.6 SUBMISSION FEES.....	33
5.7 ARC ACTION ON SUBMITTALS.....	33
5.8 APPROVAL FROM ADDITIONAL ENTITIES .....	33
5.9 EXPIRATION OF PERMITS.....	33
5.10 VARIANCES.....	33
5.11 CONSTRUCTION TIMELINE .....	34
5.12 INSPECTION PROCEDURES AND PENALTIES.....	34
5.13 REMEDIES .....	35

5.14	CHANGES IN REVIEW PROCESS .....	36
5.15	GOVERNMENTAL REGULATIONS .....	36
5.16	JOB SITE PROCEDURES.....	36
<b>VI.</b>	<b>EXHIBITS &amp; DIAGRAMS.....</b>	<b>38</b>
	EXHIBIT “A1” – ARCHITECTURAL STYLE EXAMPLES: (CRAFTSMAN) .....	39
	EXHIBIT “A2” – ARCHITECTURAL STYLE EXAMPLES: (MID-CENTURY MODERN) .....	40
	EXHIBIT “A3” – ARCHITECTURAL STYLE EXAMPLES: (MODERN / CONTEMPORARY) .....	41
	EXHIBIT “A4” – ARCHITECTURAL STYLE EXAMPLES: (MODERN FARMHOUSE) .....	42
	EXHIBIT “A5” – ARCHITECTURAL STYLE EXAMPLES: (MODERN PRAIRIE).....	43
	EXHIBIT “A6” – ARCHITECTURAL STYLE EXAMPLES: (TEXAS VERNACULAR) .....	44
	EXHIBIT “A7” – ARCHITECTURAL STYLE EXAMPLES: (TRADITIONAL / COLONIAL) .....	45
	EXHIBIT “A8” – ARCHITECTURAL STYLE EXAMPLES: (TRANSITIONAL) .....	46
	EXHIBIT “A9” – ARCHITECTURAL STYLE EXAMPLES: (VICTORIAN).....	47
	EXHIBIT “A10” – COLOR SCHEME EXAMPLES – (MODERN / CONTEMPORARY).....	48
	EXHIBIT “A10” – COLOR SCHEME EXAMPLES – (CRAFTSMAN) .....	48
	EXHIBIT “A11” – COLOR SCHEME EXAMPLES – (MID-CENTURY MODERN) .....	49
	EXHIBIT “A11” – COLOR SCHEME EXAMPLES – (MODERN FARMHOUSE) .....	49
	EXHIBIT “A12” – COLOR SCHEME EXAMPLES – (MODERN PRAIRIE).....	50
	EXHIBIT “A12” – COLOR SCHEME EXAMPLES – (TEXAS VERNACULAR).....	50
	EXHIBIT “A13” – COLOR SCHEME EXAMPLES – (TRADITIONAL) .....	51
	EXHIBIT “A13” – COLOR SCHEME EXAMPLES – (TRANSITIONAL) .....	51
	EXHIBIT “A14” – COLOR SCHEME EXAMPLES – (VICTORIAN) .....	52
	EXHIBIT “B1” – SETBACKS: URBAN YARD HOME – TYPICAL.....	53
	EXHIBIT “B2” – SETBACKS: URBAN YARD HOME – (SWING-IN GARAGE CONFIGURATION).....	54
	EXHIBIT “B3” – SETBACKS: MOTOR COURT HOME – (LOT “TYPE A” – PULL-IN CONFIGURATION) .....	55
	EXHIBIT “B4” – SETBACKS: MOTOR COURT HOME – (LOT “TYPE A” – SIDE ENTRY CONFIGURATION) .....	56
	EXHIBIT “B5” – SETBACKS: MOTOR COURT HOME – (LOT “TYPE B” – SIDE ENTRY CONFIGURATION) – OPTION 1.....	57
	EXHIBIT “B6” – SETBACKS: MOTOR COURT HOME – (LOT “TYPE B” – SIDE ENTRY CONFIGURATION) – OPTION 2.....	58
	EXHIBIT “B7” – SETBACKS: MINI MOTOR COURT HOME – TYPICAL.....	59
	EXHIBIT “C1” – FENCE DETAIL: 6’ WOOD, GOOD NEIGHBOR.....	60
	EXHIBIT “C2” – FENCE DETAIL: 6’ METAL .....	61
	EXHIBIT “C3” – FENCE DETAIL: 6’ WOOD, GOOD NEIGHBOR SHARED SIDE FENCE WITH 6’ METAL FRONT FENCES.....	62
	EXHIBIT “C4” – FENCE DETAIL: 6’ METAL SCREENING GATE (DETAIL) .....	63
	EXHIBIT “C5-A” – FENCE DETAIL: 6’ METAL FRONT FENCE - CORNER LOT - TYPICAL .....	64
	EXHIBIT “C5-B” – FENCE DETAIL: 6’ METAL FRONT FENCE – LOT WITH A SIDE AMENITY OR LANDSCAPE RESERVE.....	65
	EXHIBIT “C6” – FENCE / LANDSCAPE DETAIL: SCREENING FRONT FENCE PANELS (BETWEEN HOUSES) .....	66
	EXHIBIT “C7” – FENCING: URBAN YARD HOME – (BACK TO BACK LOTS) .....	67
	EXHIBIT “C8” – FENCING: URBAN YARD HOME – (SIDE AMENITY) .....	68
	EXHIBIT “C9” – FENCING: URBAN YARD HOME - (REAR AMENITY).....	69
	EXHIBIT “C10” – FENCING: URBAN YARD HOME - (PERPENDICULAR CORNER LOT) .....	70
	EXHIBIT “C11” – FENCING: MOTOR COURT HOME .....	71
	EXHIBIT “C12” – FENCING: MINI MOTOR COURT HOME - TYPICAL.....	72
	EXHIBIT “C13” – SECTION FENCE & DRIVEWAY LAYOUTS.....	73
	EXHIBIT “D1” – LANDSCAPING: YARD ZONES – URBAN YARD HOMES.....	74
	EXHIBIT “D2” – LANDSCAPE REQUIREMENTS: URBAN YARD HOMES - FRONT YARD.....	75
	EXHIBIT “D3-A” – LANDSCAPE REQUIREMENTS: URBAN YARD HOMES – CORNER LOT – SIDE YARD .....	76
	EXHIBIT “D3-B” – LANDSCAPE REQUIREMENTS: URBAN YARD HOMES – CORNER LOT – SIDE YARD (PERSPECTIVE).....	77
	EXHIBIT “D4-A” – LANDSCAPE REQUIREMENTS: URBAN YARD HOMES - SIDE YARD AT AMENITY .....	78
	EXHIBIT “D4-B” – LANDSCAPE REQUIREMENTS: URBAN YARD HOMES – SIDE YARD AT AMENITY (PERSPECTIVE) .....	79
	EXHIBIT “D5” – LANDSCAPE REQUIREMENTS: URBAN YARD HOMES – REAR YARD AT AMENITY .....	80
	EXHIBIT “D6” – LANDSCAPE REQUIREMENTS: URBAN YARD HOMES – PERPENDICULAR CORNER LOT.....	81
	EXHIBIT “D7” – LANDSCAPE REQUIREMENTS: MOTOR COURT & MINI MOTOR COURT HOMES - YARD ZONES.....	82
	EXHIBIT “D8” – LANDSCAPE REQUIREMENTS: MOTOR COURT & MINI MOTOR COURT HOMES – TYPICAL LAYOUT .....	83
	EXHIBIT “D9” – LANDSCAPE REQUIREMENTS: APPROVED PLANT LIST .....	84
	EXHIBIT “E1” – DRIVEWAY REQUIREMENTS: PER CITY OF AUSTIN - (PAGE 1).....	85
	EXHIBIT “E2” – DRIVEWAY REQUIREMENTS: PER CITY OF AUSTIN - (PAGE 2).....	86
	EXHIBIT “E3” – DRIVEWAY REQUIREMENTS: PER CITY OF AUSTIN - (PAGE 3).....	87
	EXHIBIT “E4” – DRIVEWAY REQUIREMENTS: PER CITY OF AUSTIN - (PAGE 4).....	88

EXHIBIT "E5" – DRIVEWAY REQUIREMENTS: 3-CAR GARAGE - (FRONT LOADED) ..... 89  
EXHIBIT "F1" – PLAN REPETITION..... 90  
**VII. SUPPLEMENTAL GUIDELINES..... 91**



## I. GENERAL

### 1.1 Community Vision

Easton Park is designed to have the core elements of a “long-standing established neighborhood” with a playful modern twist. By carefully crafting each Section with a mixture of housing products and amenities, the neighborhoods in Easton Park are able to appeal to a wide range of users. While diversity and choice are celebrated in Easton Park, it is important for all residents to realize that their home is “one piece of a greater whole” and that the importance of placement, size, texture and color of each piece is what unites the community together.

### 1.2 Builder Responsibility

Builders are solely responsible and liable for ensuring that all construction and/or improvements meet or exceed all applicable codes, good building practices and comply with all local and federal regulations, laws, etc. Each builder is ultimately responsible to make sure every home is built to be in full compliance with these Guidelines.

### 1.3 Definitions

The following definitions are provided to ensure a mutual understanding of significant terms used in this document.

#### **Amenity**

A desirable feature, facility or location in the community, such as a: lake, reserve, preserve, public venue, park, side street (Corner Lots), etc.

#### **Amenity Lot**

A Lot which fronts, side and/or rears a desirable feature, facility or location in the community, such as a: lake, reserve, preserve, public venue, park, side street (Corner Lots), etc.

#### **Applicant**

Any Builder or other entity who or which has made or intends to make a submittal to the ARC.

#### **Architectural Review Committee (ARC)**

Referred to in the Master Covenants as the “Easton Park Reviewer”, the ARC is a special committee appointed by the Developer to review and approve all proposals made for improvements within Easton Park. The Architectural Review Committee (ARC) will administer these Guidelines.

#### **Block**

A specified collection of residential streets, Lots and reserves.

#### **Corner Lot**

A Lot bounded by street right of way or landscape reserve on at least two sides.

#### **Developer**

Brookfield Residential / Carma Easton LLC, and its successor or assigns.

#### **Easement**

The right of another party (e.g., a utility company, governmental authority, etc.) to use a portion of an individual property for a limited purpose, as set out in a Plat, the Covenants, or an Easement agreement recorded in the Travis County Real Property Records. The Easements established by the Covenants (the “Covenant Easements”) affect all Lots and provide a buffer zone between properties to minimize the impact of one Lot upon the other. They are set aside to provide utility service and drainage to the surrounding area, and natural vegetative screening and privacy separations between Lots. Many Lots in Prospect Park are also affected by Drainage Easements (D.E.), Storm Sewer Easements (S.S.E.), Sanitary

Sewer Easements (S.E.), Public Utility Easements (P.U.E.), Joint Use Access Easement (J.U.A.E.), and Pathway Easement (P.E.).

**Front Yard**

*(Reference Exhibits: "D1" & "D7")*

**Interior Lot**

A Lot which faces a public right of way only on the front and which has other residential Lots adjacent on both sides.

**Prospect Park Residential Development Guidelines (the "Guidelines")**

A document containing basic planning principals, general development program, the development review process and standards required for development within Prospect Park.

**Landscaping**

The combination of natural elements such as trees, shrubs, ground covers, vines, and other living organic and inorganic material.

**Lot**

A single parcel of land intended for residential use.

**Lot Designation**

All Lots in Prospect Park will be designated as either "Urban Yard Home", "Motor Court" or "Mini Motor Court".

**Open Space Area**

Refer to definition for "Amenity Lot" above.

**Owner**

The Owner of record title to the fee interest in any tract of land, whether or not they reside on the tract.

**Parkway Strip**

The area within the Right-of-Way between the edge of public sidewalk and back of curb.

**Plat**

A map of land divisions within Prospect Park that shows individual Lots, property lines, building setback lines, streets, certain Easements and other matters. Plats are legal documents recorded in the Real Property Records in the Travis County Clerk's Office.

**Property Survey**

A scale drawing of an individual Lot showing all Easements, platted building lines, and the exact location of all structures and improvements within the Lot, prepared and certified by a surveyor or engineer.

**Rear Yard**

*(Reference Exhibits: "D1" & "D7")*

**Section**

A specified collection of residential streets, Lots and reserves.

**Side Yard**

*(Reference Exhibits: "D1" & "D7")*

**Sign**

Any device, structure, fixture or placard using graphics, symbols and/or written copy of the primary purpose of identification or advertising any establishment, product, goods or services.

**Single-Family Dwelling**

A structure designed for the residential use of a single family.

**Single-Family Lot**

A Lot or tract of land upon which one or more Single-Family Dwellings has or will be built.

**Right-of-Way (R.O.W.)**

The Right-of-Way are the areas between platted Lot lines on one side of the street and platted Lot lines on the opposite side of the street, including the paved roadway, any median or cul-de-sac islands, the drainage ditch (if any) and a strip of land between the paved roadway and the platted Lot line. Right-of-Way are dedicated to the county or other public bodies for public access, drainage and utility purposes. Right-of-Way are usually shown on the Plat of a subdivision.

**Village**

Easton Park will be composed of multiple residential Villages. (i.e. Prospect Park, Pilot Park, Discovery Park, Kieke Park, Skyline Park, Union Park, etc.) Each Village is composed of a series of Sections.

*(The remainder of this page is left blank intentionally.)*

## II. DESIGN

### 2.1 Architectural Styles

The exterior architectural style shall be consistent with the character of the community and all elements of a home shall be architecturally compatible to a particular style as determined solely by the ARC on a case-by-case basis. The ARC retains the right to disapprove any elevation.

The architectural styles for Prospect Park are:

- Craftsman
- Mid-Century Modern
- Modern / Contemporary
- Modern Farmhouse
- Modern Prairie
- Texas Vernacular
- Traditional / Colonial
- Transitional
- Victorian

An architectural character table describing the iconic features for each style along with example photos are provided in these Guidelines. This table contains primary identifying characteristics for the specified style and recommendations on how each element can be included in the building design. The features and materials listed within these tables are not absolute. A home builder may include additional materials and elements as long as they are consistent with the desired architectural style.

*(Reference Exhibits "A1" – "A9")*

### 2.2 Plan Repetition

Plan repetition shall be as follows:

PLAN	ELEVATION	MIN. NUMBER OF LOTS IN BETWEEN OR ACROSS THE STREET*
Same	Same	3
Same	Different	1

\*If the Same Plan is across the street, the first Lot across the street is considered the first of the required separation Lots.

*(Reference Exhibits "F1")*

### 2.3 Color & Material Repetition

- A. The use of diversified material palettes is strongly encouraged to avoid monotony of the street scene.
- B. The dominant colors (including paint, brick, stone, stucco, etc.) should have a minimum of five (5) Lots in between. If the Plan is across the street, the first Lot across the street is considered the first of the required separation Lots.
- C. The builder is solely responsible for complying with the Design Palette Standards. The Developer, the ARC or its designee are NOT responsible for ensuring that colors and material use does not violate repetition requirements.

- D. The ARC reserves the right to deny an elevation that is primarily similar to the elevation of a nearby house.

## 2.4 Lot Designations

All Lots in Prospect Park have one (1) of the following **Lot Designations**:

- **Urban Yard Home** - (“Single-Family Dwelling”)
- **Motor Court** - (“Quad”)
- **Mini Motor Court** - (“Mini-Quad”)

## 2.5 General Requirements – (All Homes)

Below are the general requirements for ALL homes regardless of Lot Designation. Additional specific requirements for each Lot Designation will be provided in Sections 2.6 & 2.7 below.

### A. Wildland-Urban Interface Code (WUIC)

Builders are required to install vent screens for ember protection on applicable vents on all homes per the “Wildland-Urban Interface Code”, section § 504.10, available at [www.AustinTexas.gov](http://www.AustinTexas.gov). Please note that this section § reference may change without notice and that it is the sole responsibility of the builder to ensure that the most current version of any and all codes are followed.

### B. Garages

- (1) Each house shall have a garage capable of accommodating a minimum of two (2) full-size automobiles and a maximum of three (3); with the exception of Mini Motor Court Homes, which shall have a garage capable of accommodating a minimum of one (1) full-size automobile(s) and a maximum of two (2).
- (2) For three (3) car garages the third bay is set back a minimum of one (1’) foot front the other two (2) bays.
- (3) Garage doors shall not exceed eight (8’) foot in height of typical home garages.
- (4) All garage doors must be of equal height.
- (5) All garage doors shall be a decorative panel metal or wood of an appropriate design for the home’s architectural style. No particle board or fiberglass doors are permitted.
- (6) **Swing-In Garages**  
Where a swing-in garage, at the front plane of the house, the wall facing the street may not be solid. Windows with shutters or blinds, and/or architectural embellishment will be required to soften the effect of the garage and will be established on a case-by-case basis based on visibility.
- (7) **Carports**  
Carports are prohibited.

*(The remainder of this page is left blank intentionally.)  
(This section is continued on the following page.)*

## C. Roofs

### (1) Roof Material

The roof material shall be appropriate to the home's architectural style. If composition shingles are used, they must be architectural/dimensional with a 30-year warranty. The use of 3-Tab shingles is prohibited.



### (2) Exposed Roof Penetrations

All exposed stack vents, skylight curbs, attic ventilators, and other metal roof accessories shall match or closely resemble the roofing color. Roof and valley flashing shall be of a pre-finished or painted to match the roof color. Glossy finishes are prohibited.

## D. Chimneys

- (1) If used, must be appropriate for the home's architectural style.
- (2) Exposed metal flues are not allowed. They may be used only when faced with the brick/ masonry or Hardie siding used on the house.
- (3) Heights of chimneys shall meet all fire code requirements and be proportional to the roofline of the respective home.
- (4) Direct vents located on exterior walls of the home must be painted with high-temperature paint which is the same color as the surface material they project out from.
- (5) Spark arrestors and caps are required on all chimneys. The spark arrestor and cap shall be unadorned and designed to match or be compatible with the color, material and architectural style of the exterior elevations of the home. Caps shall be of metal or masonry construction. Spark arrestors may not exceed the height of the chimney cap. All chimney caps must be painted with a matte finish paint to coincide with the color scheme of the home.

## E. Address Plaque

All homes must have an address plaque or numerals permanently affixed to the front elevation of the home in a conspicuous location easily visible from the street. The panel shall be located on the front façade of the house or garage facing the street for which the address of the home is designated. Logos of any kind are not permitted on address plaques.

## F. Security Devices/Bars

- (1) Security devices such as cameras, sirens and speaker boxes shall be the minimum size needed to be effective and shall be located in the least conspicuous location while allowing satisfactory performance.
- (2) Security and/ or burglar bars on the exterior of homes are not permitted.
- (3) If security devices are being considered for a home, the builder shall utilize a device which is minimally visible to public view and preferably mostly contained within the home.
- (4) Cameras are to be located under the eaves of the home and the camera(s) or their field(s) of vision shall not be placed to be focused on any neighboring property.
- (5) All cabling must be concealed.

## G. Exterior Materials/Colors (“Design Palette Standards”)

The design palette of a residence directly impacts the street scene on which it is located. By having multiple palettes, it increases the visual diversity of the neighborhood while still providing harmony within the community and natural environment. The materials and colors of each design palette must complement the architectural style of the building.

The builder is solely responsible for complying with the Design Palette Standards. The Developer, the ARC or its designee are NOT responsible for ensuring that colors and material use does not violate repetition requirements.

The ARC reserves the right to reject any design palette that does not reinforce the architectural character or precedence of an architectural style.

The following standards shall apply to the design palettes utilized in Prospect Park:

### (1) Design Palettes

#### (a) Color & Materials Repetition

*(Reference Section 2.3)*

#### (b) Materials

All major proposed (primary and accent) cladding materials to be used on a single building.

#### (c) Color Schemes

The specific colors chosen to be grouped together on a single elevation.

- (i) Any home offered on a repeating basis will be required to have a minimum of six (6) exterior color schemes (building material may stay the same).
- (ii) A minimum of three (3) distinct building colors (one (1) primary and two (2) accent) are required in each color scheme.
- (iii) The primary color of a structure should be non-obtrusive.
- (iv) Additional accent colors may be utilized depending on the detail and character of the home.

- (v) All paint, stain, tile, and/or other colored materials must match or complement the color scheme and architectural style of the intended dwelling.
- (vi) A variety of color schemes should be implemented to achieve a varied look in character to avoid a monochromatic appearance.

**(d) Color Scheme Examples (by Architectural Style)**

Complementary color schemes have been developed for each of the recommended architectural styles. These themes are suggestions based off of typical design elements and colors utilized within each style. They are not required to be used with the associated architectural style and can be applied to other architectural styles as appropriate.

*(Reference Exhibits "A10" – "A14")*

If a home builder desires to create their own color scheme, they may generate an "Alternate Color Scheme" with the following features:

FEATURE COLOR	COLOR LOCATION
Body Color	The primary color for the overall exterior building material.
Trim Color	The color of trims at doors, windows, openings, eaves and any body accents.
Accent Color	Features such as doors, shutters, garage doors, etc.
Fascia Color*	The color of eaves, overhangs, and possibly wood stain.
Veneer Color*	The selection of stone or brick veneer.
Metal Color*	Features like iron work details, railings, gates, grilles, etc.
Precast Color*	Trims, surrounds or caps accents

\*As needed for specific architectural styles utilizing these materials/details.

**(e) Material Cladding of Foundation**

No more than eighteen (18") inches (vertical dimension) of concrete foundation may be exposed to public view. If more than eighteen (18") inches of foundation is exposed, the exterior materials must be brought down over the face of the foundation or screened and maintained with evergreen shrubs to minimize the amount of exposed slab.

**(2) Painting / Colors of Pipes, Vents & Functional Louvered Vents**

All wall extrusions / penetrations, equipment attached to exterior walls or similar, including, but not limited to pipes (PVC, metal, etc.), wall vents, utility meters, exposed flashing, etc. must be the same color as the surface material they project out from or to which they are directly attached.

**(3) Enhanced Cladding Materials**

At a minimum, enhanced cladding materials shall be used on the front elevation and material returns on side elevations and may include masonry, stucco, wood shingles and metal, wood, vinyl or fiber cement siding applied authentic to the home's particular style of architecture.



**(4) Wall Material Transitions**

All transitions between materials shall occur at logical points in the elevation. Where there is a material transition from front elevation's primary material to another approved material on a side elevation, the front elevation's primary material is encouraged, but not required, to extend back at least five (5') feet or to a logical transition point, whichever is greater.

**(5) Brick**

Only earth tone colors are acceptable. Painted brick, including whitewashed, will be permitted on a case-by-case basis as determined by the ARC and shall be of a matte finish. Brick shall meet standard specifications established by The Brick Institute of America.

**(6) Stone**

Any and all stone utilized on the exterior of a home shall be earth tones.

**(7) Masonry Mortar Joints**

All mortar joints shall be tooled. Mortar colors if used, shall be selected to complement the brick or stone color. Caulking of vertical expansion joints and border joints must match mortar color.

**(8) Siding**

Traditional applications of siding are typically installed horizontally and include panels, traditional lap or Dutch lap with an exposed panel greater than four (4") inches. The use of particle board, or any sheet siding is prohibited.

**(9) Stucco**

If used, the use of authentic stucco is required and must be installed by a certified professional. The use of matte-finished stucco board is prohibited. The stucco shall conform in color with all other exterior housing materials.

The use of matte-finished stucco board is only permitted on the sides and rear of the home if it does not side or rear a street or an amenity such as, but not limited to, a corner lot, lake, greenbelt, trail, or is otherwise visible to the public. The stucco shall conform in color with all other exterior housing materials.

**(10) Trim**

All trim shall be smooth/ semi-smooth, high-quality finish grade stock wood or fiber cement board.

**(11) Windows**

Window type/color/finish shall be complementary to the overall character of the home's design. Reflective, "mirrored" or tinted glass other than bronze or gray is not permitted. Materials in windows such as newspaper, aluminum foil, etc. are strictly prohibited.

**(12) Awnings**

Canvas awnings are prohibited.

*(Continued on following page.)*

*(The remainder of this page is left blank intentionally.)*

## H. Exterior Building Lighting

- (1) Lights may not be mounted in a way or installed in locations which will allow them to shine onto or be a nuisance to neighboring properties. Any lighting on individual Lots shall be directed away from adjoining property. Light sources shall not conflict with the sight lines of pedestrians or motorists in a manner which endangers their safety and welfare.
- (2) The ARC and/or HOA retain the right to require additional shielding, screening and or removal of lights and fixtures (at the current Owner's sole expense) which are deemed a nuisance at the sole discretion of the ARC and/or HOA.
- (3) All light fixtures and their locations shall be submitted (clearly noted on the plans) to the ARC and Applicant must receive written approval from the ARC prior to installation.
- (4) All exterior illumination shall be designed and located to encourage conformance to "Dark Sky" principles. "Dark Sky" principles include avoiding adverse impact of artificial light including sky glow, glare, light trespass, light clutter, decreased visibility at night, and energy waste.
- (5) Exterior mounted lamp housings must shield lamp from view and the direct light.
- (6) All exterior lighting, including LED lights must be of soft, warm white lighting and shall not exceed a light output of seventy-five (75) watts or equivalent. Decorative or lantern fixtures shall not exceed a light output of forty-five (45) watts or equivalent per fixture.
- (7) Incandescent, low voltage incandescent, metal halide, quartz and natural gas lights are acceptable. Sodium, mercury vapor, or bare HID yard lights are prohibited.
- (8) Conduits and wiring shall remain concealed from view of the neighboring Lots and all public views.
- (9) Each home will be required to have a minimum of one (1) front porch light fixture, either wall-mounted or recessed soffit lighting.
- (10) Each home will be required to have a minimum number of light fixtures on the front garage elevation.

*(Reference Section "2.6 Urban Yard Home Requirements" and "2.7 Motor Court & Mini Motor Court Home Requirements".)*

- (11) Flood lights may not be mounted higher than the first-floor plate height and may not be located on the front elevation.

### (12) Soffit/Eve-Mounted Accent Lights

#### (a) General

Lights may not be mounted in a way or installed in locations which will allow them to shine onto or be a nuisance to neighboring properties.

#### (b) Front Elevation

Recessed soffit/eve-mounted accent lights may be used on the first (1st) story and second (2nd) story of the front elevation.

#### (c) Side & Rear Elevation

Recessed soffit/eve-mounted accent lights may only be used on the first (1st) story of side or rear elevations which do not face an adjacent residential Lot. (i.e. A side elevation which faces either a side street on Corner Lots or faces an Amenity is authorized. A rear

elevation which faces an Amenity is authorized.)

**(d) If used, soffit/eve-mounted accent lights:**

- (i)** Must be fully recessed (the bulb and/or lens may not extend out of the can).
- (ii)** Lights must be angled straight down.
- (iii)** Lights may not exceed forty (40) watts or equivalent output.
- (iv)** One (1) light temperature must be used for all lights, which must be between 2700K and 3000K to produce soft warm white illumination.
- (v)** Lights must be static. Lights which flash or pulse are strictly prohibited.
- (vi)** Light cans and trim must match the color of the soffit/eve to which it is installed.
- (vii)** Lights may not be mounted in a way or installed in locations which will allow them to shine onto and/or be a nuisance to neighboring properties.

**I. Antennas**

- (1)** Television antennas on roofs shall be avoided.
- (2)** If placed outside, the antenna shall not encroach on neighboring private or public property.
- (3)** Antennas, satellite dishes, and radio towers shall be located in the least conspicuous location while still allowing for satisfactory reception.
- (4)** If multiple locations will provide satisfactory reception, the least conspicuous location must be used.
- (5)** If the antenna is placed on the site, it is suggested that the smallest antenna possible be used to avoid attention.
- (6)** The ARC reserves the right to require additional vegetation and/or fence screening, as determined on a case-by-case basis to minimize visibility to the public and/or neighboring properties.
- (7)** Radio towers are prohibited.
- (8)** All cabling shall be concealed.

**ATTENTION**

***(Supplemental/Additional Requirements, specific to each Lot Designation, are on the following pages.)***

*(The remainder of this page is left blank intentionally.)*

## 2.6 Urban Yard Home – Requirements

In addition to the General Requirements (for ALL homes) provided in Section 2.5, below are the specific requirements for all Urban Yard Homes.

### A. Lot Coverage

The total of all hard surfaces created during initial construction of the residence (including: building pad, garage, Driveway, Private Walkways, porches, patios, etc.) shall not exceed:

Sixty-Five (65%) Percent Maximum

### B. Lot Setbacks

(Reference Exhibits: “B1” – “B2”)

### C. Square Footage

ALL air-conditioned interior space shall be measured to the outside of exterior walls (i.e., outside of brick, siding, stone, or stucco) and be included in the house square footage. Stairs and two-story spaces shall only be counted once.

The allowable square footage for all Urban Yard Homes in Prospect Park shall be:

LOT WIDTH	MINIMUM SQFT.	MAXIMUM SQFT.
50'	1,900	3,200
60'	2,450	No Maximum

### D. Minimum House Width

The minimum width of a house shall be no less than fifteen (15') feet narrower than the applicable typical product Lot width. See examples below.

TYPICAL LOT WIDTH	MINIMUM HOUSE WIDTH
50'	35'
60'	45'

### E. Private Walkways

A minimum of one (1) walkway, which complies with the City of Austin Visitability requirements, must extend from the primary entrance of a home to a public pedestrian sidewalk or front driveway.

If another walkway is provided from the home to a public pedestrian sidewalk or front driveway it does not have to be compliant with the City of Austin Visitability requirements and may be constructed of materials compatible with the architectural style of the home (i.e. pavers, stepping stones, etc.)

Private Walkways shall be a maximum width of four (4') feet.

### F. Public Sidewalks

Builder is responsible for installing a four (4') foot public sidewalk which shall be constructed per the construction documents for Typical Roadway Sections, as provided by the Developer.

All public sidewalks must be doweled and properly reinforced.

## G. Driveways

Some driveway locations may be predetermined and will be identified on the “Section Fence & Driveway Layouts” available online at [www.KenAnderson.com](http://www.KenAnderson.com) > [Residential](#) > [Easton Park](#).

On Corner Lots, where driveway is on same side as front elevation, builder must locate the driveway on the interior side of Lot.

To maintain a clear path for fire access on local roads, some Lots within Prospect Park have been designated with specific driveway locations (either the left or right side of the Lot). These Lots are identified on the “Section Fence & Driveway Layouts”.

### (1) Driveway Responsibility/Construction

Builders are required to install the driveway out to the street using best professional practices, to include reinforcement of concrete and expansion joints. All driveways must be constructed per the 6.5 CITY OF AUSTIN FLARED TYPE 1 DRIVEWAY (NO. 433S-IA).

*(Reference Exhibits: “E1” – “E4”)*

### (2) Driveway Materials

All driveways shall be standard-gray reinforced concrete.

### (3) Driveway Widths – (2-Car Garage)

Driveways serving two (2) car garages shall be:

#### (a) Location

Centered on the garage door.

#### (b) Minimum Width (at the Property Line)

(i) **Front-Load Garage** (Garage door parallel with the street.)  
Sixteen (16') Feet

(ii) **Swing-In Garage** (Garage door perpendicular with the street.)  
Twelve (12') Feet

#### (c) Maximum Width

##### (i) At Garage

May not extend more than six (6”) inches beyond the side edge(s) of the garage or twenty-five (25') feet, whichever is less.

##### (ii) At Public Sidewalk

Driveways which are wider than seventeen (17') feet at the garage shall gently taper down to a maximum width of seventeen (17') feet at the interior edge of the Public Sidewalk.

**(4) Driveway Widths – (3-Car Garage)**

Driveways serving three (3) car garages shall be:

- (a)** All Urban Yard Homes garage configurations are allowed to have three (3) car garages. Paved space, which does not lead directly into a garage door, is prohibited.

- (b) Garage**

- (i)** For three (3) car garages, in which all doors are facing the street (side-by-side), the third garage bay shall be recessed a minimum of one (1') foot. A landscape planter at the driveway taper is required in this configuration.

*(Reference Exhibit "E5")*

- (ii)** All Swing-In configurations will be permitted to have a side-by-side three (3) car garage.

- (c) Minimum Width**

- (i) Front-Load Garage** (Garage door parallel with the street.)  
Sixteen (16') Feet

- (ii) Swing-In Garage** (Garage door perpendicular with the street.)  
Twelve (12') Feet

- (d) Maximum Width**

- (i) At Garage**  
May not extend more than six (6") inches beyond the side edge(s) of the garage or twenty-eight (28') feet, whichever is less.

- (ii) At Public Sidewalk**  
Driveways which are wider than twenty (20') feet at the garage shall gently taper down to a maximum width at the interior edge of the Public Sidewalk of twenty (20') feet.

*(Reference Exhibit "E5")*

**H. Lighting**

Each Urban Yard Home will be required to have a minimum of two (2) wall-mounted light fixtures on the front garage elevation.

**I. Landscaping**

*(Reference section "IV. LANDSCAPE". For landscaping requirements, specific to Urban Yard Homes, see section "4.12" – "4.13".)*

**2.7 Motor Court & Mini Motor Court Home – Requirements**

In addition to the General Requirements (for ALL homes) provided in Section 2.5, below are the specific requirements for all Motor Court & Mini Motor Court Homes.

**A. Lot Coverage**

The total of all hard surfaces created during initial construction of the residence (including: building pad, garage, Driveway, Private Walkways, Public Sidewalks, porches, patios, etc.) shall not exceed coverage percentages noted below.

- (1) Motor Court**  
Seventy (70%) Percent Maximum
- (2) Mini Motor Court**  
Seventy-Five (75%) Percent Maximum

**B. Lot Setbacks**

*(Reference Exhibits: “B3” – “B7”)*

**C. Square Footage**

ALL air-conditioned interior space shall be measured to the outside of exterior walls (i.e., outside of brick, siding, stone, or stucco) and be included in the house square footage. Stairs and two-story spaces shall only be counted once.

The allowable square footage for all Motor Court & Mini Motor Court homes in Prospect Park shall be:

LOT DESIGNATION	MINIMUM SQFT.	MAXIMUM SQFT
Mini Motor Court (“Mini Quad”)	1,400	2,100
Motor Court (“Quad”)	1,900	No Maximum

**D. Minimum House Width**

The minimum width of a house shall be as follows:

TYPICAL LOT WIDTH	MINIMUM HOUSE WIDTH
45'	32'
60'	32'

**E. Driveway Widths**

Overall dimension of all shared driveways shall be centered on the property line.

- (1) Minimum Width**  
Fourteen (14') feet
- (2) Maximum Width**  
Twenty (20') feet

**F. Garages**

Mini Motor Court Homes shall have a garage capable of accommodating a minimum of one (1) full-size automobile(s) and a maximum of two (2).

**G. Lighting**

Each Motor Court and Mini Motor Court Homes will be required to have a minimum of one (1) wall-mounted light fixture on the front garage elevation.

**H. Landscaping**

*(Reference section "IV. LANDSCAPE")*

*(The remainder of this page is left blank intentionally.)*



### III. FENCING

#### 3.1 General

This chapter outlines required fencing locations and types.

#### 3.2 Fence Responsibility

Fencing as referred to in these Guidelines will be the responsibility of each builder as they develop Lots, unless otherwise designated as a Developer installed fence on the Section Fence & Driveway Layouts.

*(Reference "Section Fence & Driveway Layouts" available online at [www.KenAnderson.com](http://www.KenAnderson.com) > [Residential](#) > [Easton Park.](#))*

#### 3.3 Fence Types & Requirements

##### A. General

It is the current property Owner's sole responsibility to ensure that any fence and/or gate be pool barrier compliant and be inspected and approved by an actively certified third-party inspector.

- (1) Locations of each fence type will be marked on the "Section Fence & Driveway Layouts".

*(Reference "Section Fence & Driveway Layouts" available online at [www.KenAnderson.com](http://www.KenAnderson.com) > [Residential](#) > [Easton Park.](#))*

- (2) No exposed ends will be permitted and the fence end must match the profile of the fence.
- (3) All fence hardware connections are to be screw or ring shank nails, on a straight-line guide.
- (4) No used or reclaimed material is allowed.
- (5) Fences are to be kept in good repair.

##### B. Wood Fence – Good Neighbor

All fences indicated to be "6' Good Neighbor Wood Fence" on the "Section Fence & Driveway Layouts" which do not face a public view shall be six (6') foot solid picket (alternating panels).

*(Reference Exhibit: "C1")*

*(Reference "Section Fence & Driveway Layouts" available online at [www.KenAnderson.com](http://www.KenAnderson.com) > [Residential](#) > [Easton Park.](#))*

All wood fence elements, within Prospect Park, shall be stained one (1) consistent color throughout the neighborhood, utilizing two (2) coats of stain (BEHR Semi-Transparent Cedar Chatham Fog #ST-154) or Developer approved equal.

##### C. Metal Fence

All fences indicated to be "6' Metal Fence" on the "Section Fence & Driveway Layouts" shall be of a manufactured product that uses pre-galvanized steel with a zinc rinse and a black powder coat finish. All metal fencing will be of a design that allows it to easily accommodate changes in elevation by use of a rackable system.

All metal fencing will have a flush mount rails (flat top, flat bottom). All metal fencing will have a minimum twenty (20) year manufacturer warranty. Tube steel fence shall meet or exceed these specifications or Developer approved equal.

*(Reference Exhibit: "C2")*

*(Reference "Section Fence & Driveway Layouts" available online at [www.KenAnderson.com](http://www.KenAnderson.com) > [Residential](#) > [Easton Park.](#))*

### **3.4 Fence Locations**

*(Confirm specific fencing types and locations on the "Section Fence & Driveway Layouts" available online at [www.KenAnderson.com](http://www.KenAnderson.com) > [Residential](#) > [Easton Park.](#))*

#### **A. Front Fences**

Front fences shall be set back, a minimum of five (5') feet and maximum of ten (10') feet, from front corner face of the house unless there are conflicts with windows, mechanical equipment or other architectural elements of the house.

*(Urban Yard Homes - Reference Exhibits: "C7" & "C10")*

*(Motor Court & Mini Motor Court Homes - Reference Exhibits: "C11" – "C12")*

#### **B. Side Fence (Street Side – Corner Lot)**

*(Urban Yard Homes - Reference Exhibits: "C7" & "C10")*

*(Motor Court & Mini Motor Court Homes - Reference Exhibits: "C11" – "C12")*

#### **C. Side Fence (Amenity Lot)**

Lots which sides an Amenity shall have the side fence located on the side property line and, where a side material transition occurs, the front fence shall not be located behind side material transition.

*(Reference Exhibit: "C8")*

#### **D. Side & Rear Fence (Perpendicular Lots)**

Side or rear fences on Corner Lots that perpendicular to the Lot behind them will be per the exhibit(s) referenced below.

*(Reference Exhibit: "C10")*

### **3.5 Gates**

#### **A. Front Fence Gates**

- (1)** Front gates on interior side yard fences (between two homes) are required to be one design, which shall be a Metal Screen Gate. Any open metal fence panel(s) between the gate and either the home or the adjacent property's fence line shall be screened with a metal panel, same type as used on the gate, or large (min. 3-gal.) evergreen shrub(s). A maximum eight feet (8') width of metal screen panel may be used; this includes the total width of screening panel used at the gate.
- (2)** Front gates on corner lots (secondary street side) may have a typical open metal picket gate or a Metal Screen Gate. Any open metal fence panels, not including the gate, between the house and corner fence post shall be screened with large (min. 3-gal.) evergreen shrubs.

*(Reference Exhibit(s): "C4" – "C6")*

**B. Side Fence Gates**

Gates on side fences are only permitted on Motor Court & Mini Motor Court Lots as shown in Exhibits "C11" – "C12".

**C. Rear Fence Gates**

Gates on rear fences are only permitted on Motor Court & Mini Motor Court Lots as shown in Exhibits "C11" – "C12".

**3.6 Equipment Screening**

A/C units, pool equipment or other equipment shall be fully screened from public view with landscape and/or by a Metal Screen Gate. Landscape screening shall create a solid screen immediately when planted per the requirements below.

**A. Interior Lots**

Any open metal fence panel(s) between the gate and either the home or the adjacent property's fence line shall be screened with a metal panel, same type as used on the gate, or large (min. 3-gal.) evergreen shrub(s). A maximum eight feet (8') width of metal screen panel may be used; this includes the total width of screening panel used at the gate. See Section 4.12 below.

*(Reference Exhibit: "C6")*

**B. Corner Lots & Side Amenity Lots**

Any open metal fence panels, not including the gate, between the house and corner fence post shall be screened with large (min. 3-gal.) evergreen shrubs. Buyer must install at least one native shrub at the front of the A/C Unit and or Pool Equipment. If a typical open metal picket gate is used, one additional shrub must be installed on the street-facing/Amenity-facing side of each A/C Unit. Pool Equipment, depending on the size of the cluster, may require the installation of additional shrubs to create adequate side screening. When installed at an A/C unit or utility equipment, shrubs must be at least half the height of the tallest unit it is screening and must be full, fast growing, healthy and drought resistant. See Section 4.12 below.

*(The remainder of this page is left blank intentionally.)*

## IV. LANDSCAPE

### 4.1 Landscape Approach

All Landscaping on a residential Lot must be installed, in compliance with these Guidelines, by the builder prior to the Final Compliance Inspection and closing on the home.

### 4.2 Drainage

Drainage Texas law in conjunction with the Texas Water Code requires that the Owner ensure that the placement of any improvement or Landscaping does not halt or materially impede drainage flowing off of a neighboring tract and does not redirect the flow or significantly increase the amount of water flowing onto a neighboring tract. Enforcement of this requirement is by the affected property Owner(s). The drainage from each Lot should be directed to the street where possible. In instances where the rear area of a Lot is lower than the elevation of the street, a Lot-to-Lot drainage solution may be needed. In these situations, a Lot cannot block drainage from an adjacent Lot that naturally flows across that Lot on a path to a drainage swale, stream or outlet. Enforcement of this requirement is by the affected property Owner(s).

### 4.3 Irrigation

All areas/yards on a Lot which are landscaped with sod, planter beds, vegetation and/or trees shall be fully irrigated.

Care shall be taken to avoid irrigation spray and runoff on adjacent property and public sidewalks.

A. All irrigation systems shall be:

- (1) Designed and installed by a licensed irrigator in the state of Texas.
- (2) Be equipped with a backflow prevention device as mandated by appropriate local code.

B. Builders shall instruct the homeowners in the operation of the irrigation system.

### 4.4 Sod

A. Bermuda is required on all portions of the Lot and within the Right-of-Way, including the front, side, Rear Yards, and areas extending the curb except where planter beds are installed.

B. Sodding and Landscaping of areas not on a residential Lot will be installed by the Developer and mowed/maintained by the HOA.

### 4.5 Landscape Beds

A. Landscape beds are not permitted along any portion of the public sidewalk that shares a side with the front yard, i.e., the part of the yard between the house and public sidewalk.

B. All planting beds shall be mulched with black or dark brown hardwood mulch or aggregate mulch. Other materials to be used in place of mulch will be submitted to the ARC for written approval prior to installation.

C. Aggregate mulch is allowed in planting bed areas as a replacement for turf areas. If used, aggregate mulch beds must be installed with a weed barrier fabric and an approved edging border.

D. Aggregate mulch must have a minimum diameter of three-eighths (3/8") inch.

- E. Minimum diameter for aggregate is increased to three-quarters (3/4") inch in areas where slopes exceed five (5%) percent.

#### **4.6 Plant Bed Edging**

- A. Planter bed edging is not required. If edging is installed, it must be complementary with the materials of the residence, such as stone.
- B. Steel, aluminum, concrete, or masonry edging is preferred.
- C. Brick borders, timbers, rubber and plastic bed edges are not permitted.
- D. Plant bed edging requirements are not limited to those listed in these Guidelines. Plant bed edging materials and construction design must be approved in writing by the ARC prior to installation.
- E. Bed edges at a minimum must be "V-Cut".

#### **4.7 Plant Material**

A list of appropriate planting material is available in the *"Approved Plant List" (Exhibit "D9")*. Other plant material may be utilized if approved in writing by the ARC. However, plants provided in the *"Approved Plant List"* are preferred and shall be the predominate plant material. Builders are encouraged to use a blend of plant materials and layouts to avoid monotony of the streetscape.

#### **4.8 Installation**

Careful consideration shall be taken when planting large trees and shrubs near the foundation and hard surface areas to avoid damage by the plant's root system. Trees, shrubs and planter beds placement shall not halt or materially impede drainage flowing off of a neighboring tract and does not redirect the flow or significantly increase the amount of water flowing onto a neighboring tract.

Avoid planting trees and/or large shrubs in close proximity to the address plaque to maintain a clear view corridor from a majority of the street.

#### **4.9 Gravel & Rock**

Gravel and rock may be used (as a mulch option in front yards), but is not permitted for use or substitution for shrubs, ground cover, and may not extend to within twenty-four (24") inches of the interior side of the public sidewalk, i.e., the section of public sidewalk on the front yard side.

#### **4.10 Maintenance**

Each property Owner is required to mow their yards (including the Front Yard area between the front property line and the back of curb) and maintain all landscaped areas within their property.

#### **4.11 Parkway Strip Landscape**

The area between the back of curb and the Public Sidewalk.

- A. A sight distance area of fifty (50') feet from a street intersection must be irrigated and landscaped with sod.
- B. A sight distance area of ten (10') feet from a driveway cut may not contain plants with a mature height greater than two (2') feet.
- C. Landscape beds (when used) within the Parkway Strip must be irrigated and may only contain aggregate mulch.

**4.12 Landscape Used as Screening**

When shrubs are used as a vegetative screening for A/C units, utility equipment or along a fence line, the shrubs shall be full, fast growing, healthy, drought resistant and of an evergreen variety, such as a Dwarf Wax Myrtle or Texas Sage (as shown below). When installed at an A/C unit or utility equipment, the shrub(s) must be at least half the height of the tallest equipment it is screening. When installed along a fence, the shrubs shall be a ¼ height of the fence they are planted against or a minimum of 3-gallons, whichever is greater.

**A. Corner Side Yard**

Corner lots adjacent to a secondary street shall have screening shrubs installed on the outside of the fence along the front, not including the gate, and side street-facing panels. All sod, shrubs, and irrigation between the fence and back of street curb on the corner lot side shall be builder installed and homeowner maintained.

*(Reference Exhibit: "D3-A" & "D3-B")*

**B. Amenity Side Yard**

Lots adjacent to or that share a side property line with an Amenity or Landscape Reserve will have Developer installed landscape screening on the outside of the fence. All irrigation and shrubs will be maintained by the HOA along the exterior of the side fence.

*(Reference Exhibit: "D4-A" & "D4-B")*

**C. Amenity Rear Yard**

Lots that back up to or share a rear property line with an Amenity or Landscape Reserve will have screening shrubs installed along the inside of the rear fence. All shrubs and irrigation along the inside of the rear fence shall be builder installed and homeowner maintained.

*(Reference Exhibit: "D5")*



*Texas Sage*



*Dwarf Wax Myrtle*

**ATTENTION**

***(Supplemental/Additional Requirements, specific to each Lot Designation, are on the following pages.)***

#### 4.13 Urban Yard Home – Landscape Requirements

In addition to the General Requirements (for ALL homes) provided in Sections 4.1 – 4.12, below are the specific landscape requirements for all Urban Yard Homes.

Shade Tree trunk caliper to be measured at two (2') feet above natural grade.

##### A. Urban Yard Home - Front Yard Landscape

The total Front Yard area shall be a maximum of sixty-five (65%) percent sod. The other thirty-five (35%) percent shall be landscape beds populated with the minimums shown in *Exhibit "D2"*.

At a minimum, five-gallon (5 gal.) evergreen shrubs must be installed at four foot (4') on center to reduce the visual impact of the slab. Plants used to screen the foundation shall count towards the total required number of five-gallon (5 gal.) evergreen shrubs for that Lot.

*(Reference Exhibits: "D1" & "D2")*

##### B. Urban Yard Home - Side Yard Landscape

###### (1) Interior Side Yard(s) – Between Homes

One-hundred (100%) percent of Interior Side Yard(s) (as illustrated in *Exhibit "D1"*) may be sod (Bermuda); or natural-colored, muted (brown, tan, or black) bull rock, or decomposed granite. All areas of an Interior Side Yard shall remain permeable and shall not negatively impact drainage.

###### (2) Corner Side Yard(s)

###### (a) Corner Lots with a Secondary Street

Corner Lot Side Yard(s) adjacent to a secondary street shall have screening shrubs installed on the outside of the fence along the front, not including the gate, and side street-facing panels. All sod, shrubs, and irrigation between the fence and back of street curb on the corner lot side shall be builder installed and homeowner maintained.

Refer to the *"Approved Plant List"* (*Exhibit "D9"*) and Section 4.12 for more detailed requirements.

Landscape beds in the Side Yard must be irrigated and must be mulched with either hardwood or aggregate mulch.

A fifty (50') by fifty (50') foot sight distance triangle shall be maintained at corners. The positioning of the trees and shrubs shall also not impede pedestrian access on the public sidewalk.

*(Reference Exhibit: "D3-A" & "D3-B")*

###### (b) Corner Lots adjacent to an Amenity or Landscape Reserve

Lots adjacent to or that share a side property line with an Amenity or Landscape Reserve will have Developer installed landscape screening along the outside of the side fence. All irrigation and shrubs will be maintained by the HOA along the exterior of the side fence.

One-hundred (100%) percent of the interior (Homeowner) side of the yard(s) (as illustrated in *Exhibit "D1"*) may be sod (Bermuda); natural-colored, muted (brown, tan, or black) bull rock, or decomposed granite. All areas of an Amenity Lot's Interior Side Yard(s) shall remain permeable and shall not negatively impact drainage.

*(Reference Exhibit "D4-A" & D4-B")*

**(3) Side Yard, Perpendicular Corner Lot**  
*(Reference Exhibit "D6")*

**4.14 Urban Yard Home – Rear Yard Landscape**

- A.** Rear Yards must be fully landscaped with sod (must be irrigated) or aggregate mulch to stabilize the ground surface.
- B.** Landscape beds and tree plantings (when used) must be irrigated.
- C.** Rear Yards which rear an Amenity are required to have a continuous landscape bed along the inside of the rear fence and populated with at least the plant quantities as shown on the referenced Exhibit below, and as described in *Section 4.12*.

*(Reference Exhibit: "D5")*

*(Continued on following page.)*  
*(The remainder of this page is left blank intentionally.)*



#### 4.15 Motor Court & Mini Motor Court - Landscape Requirements

In addition to the General Requirements (for ALL homes) provided in Sections 4.1 – 4.11, below are the specific landscape requirements for all Motor Court & Mini Motor Court Homes.

Shade Tree trunk caliper to be measured at two (2') feet above natural grade.

#### 4.16 Motor Court & Mini Motor Court - Front Yard Landscape

The total Front Yard area shall be a maximum of sixty-five (65%) sod. The other thirty-five (35%) shall be landscape beds populated with the minimums shown on the referenced Exhibit below.

At a minimum, five (5) gallon evergreen shrubs must be installed at four (4') foot on center to reduce the visual impact of the slab. Plants used to screen the foundation shall count towards the total required number of 5-gallon evergreen shrubs for that Lot.

*(Reference Exhibits: "D7" & "D8")*

#### 4.17 Motor Court & Mini Motor Court - Side Yard Landscape

##### A. Interior Side Yard(s)

One-hundred (100%) percent of Interior Side Yard(s) (as illustrated in *Exhibit "D7"*) may be natural-colored, muted (brown, tan, or black) bull rock or decomposed granite. All areas of an Interior Side Yard shall remain permeable and shall not negatively impact drainage.

##### B. Corner Side Yard(s)

###### (1) Corner lots with a Secondary Street

Corner Lot Side Yard(s) (as illustrated in *Exhibit "C5-A", "D7" & "D8"*) adjacent to a secondary street shall have screening shrubs installed on the outside of the fence along the front, not including the gate, and side street-facing panels. All sod, shrubs, and irrigation between the fence and back of street curb on the corner lot side shall be builder installed and homeowner maintained.

Refer to the *"Approved Plant List" (Exhibit "D9")* and Section 4.12 for more detailed requirements.

A fifty (50') by fifty (50') foot sight distance triangle shall be maintained at corners. The positioning of the trees and shrubs shall also not impede pedestrian access on the public sidewalk.

Landscape beds in the Side Yard must be irrigated and mulched with either hardwood or aggregate mulch.

###### (2) Corner Lots adjacent to an Amenity or Landscape Reserve

Lots adjacent to or that share a side property line with an Amenity or Landscape Reserve will have Developer installed landscape screening along the outside of the side fence. All irrigation and shrubs will be maintained by the HOA along the exterior of the side fence.

*(Reference Exhibit: "C5-B" & "D8")*

One-hundred (100%) percent of the interior (Homeowner) side yard(s) (as illustrated in *Exhibit "D7" & "D8"*) may be natural-colored, muted (brown, tan, or black) bull rock or decomposed granite. All areas of an Amenity Lot's Interior Side Yard(s) shall remain permeable and shall not negatively impact drainage.

*(Reference Exhibit "D7" & D8")*

**4.18 Motor Court & Mini Motor Court - Rear Yard Landscape**

- A. Rear Yards must be fully landscaped with sod (must be irrigated).
- B. Landscape beds and tree plantings (when used) must be irrigated.

*(Reference Exhibit: "D7" & "D8")*

**4.19 Motor Court & Mini Motor Court - Courtyard Landscape**

*(Reference Exhibit: "D7" & "D8")*

*(Continued on following page.)*

*(The remainder of this page is left blank intentionally.)*

## V. PROCEDURES & SUBMISSIONS (For builders during initial home construction.)

### 5.1 General

The builder is solely responsible and liable for following the requirements of these Guidelines regardless of whether detail(s) of items are noted/called out on reviews/documentation including, but not limited to plans, permits, applications and inspections.

### 5.2 Procedure

The review process begins when a Builder submits an online application including a set of plans, drawings, specifications and other required information to the ARC for processing. Submissions shall be made online at [www.KenAnderson.com](http://www.KenAnderson.com) > [Residential](#) > [Easton Park](#).

### 5.3 Required Submission Information

The builder is required to submit the following information to be reviewed by the ARC.

#### A. Master Plans

In order to provide the shortest turnaround time for reviews the following shall be required. When submitting a Master Plan Application for review, builders shall submit:

- (1) Each elevation as a separate submission. (i.e. Elevation "A" should be a separate application/submission from Elevation "B".)
- (2) Each Master Plan (elevation) must be submitted separately for each Section of Prospect Park that the builder intends to build that plan elevation.
- (3) Each Master Plan (elevation, such as elevation "A") submission shall only include the plans, elevation, option(s), etc. sheets that pertain to that particular Master Plan (elevation).
- (4) Floor Plans
- (5) Electrical Plans (showing all exterior lighting)
- (6) Roof Plan
- (7) Material(s) location(s) clearly called out on plans.
- (8) Statement of House Square Footage
  - (a) Base square footage of the plan.
  - (b) Square footage of each option (if any) which adds livable square footage.

Square footage will be measured as follows:

- (i) To the outside of exterior walls (i.e., outside of brick, siding, stone, or stucco).
- (ii) Stairs and two-story spaces shall be counted only once.
- (iii) Unfinished area, that can be easily converted for future use, will be included.
- (iv) Exclude the following from square footage:
  - Garages, porches or other appendages.
  - A/C returns, pipe chases, fireplaces and non-structural voids.
  - Spaces with ceiling height of less than six (6') feet.

Written approval from the ARC must be received before submitting for a Building Permit.

## **B. Building Permit**

In order to provide the shortest turnaround time for reviews the following shall be required. When submitting a Building Permit Application for review, builders shall submit:

### **(1) Architectural Plans**

Architectural Plans shall include the following:

- (a)** Floor plans and (all applicable) exterior elevations for the elevation being submitted.
- (b)** Electrical Plans (showing all exterior lighting)
- (c)** Roof Plan
- (d)** Material(s) location(s) clearly called out on plans.
- (e)** Statement of House Square Footage. (Note that ALL air-conditioned interior space shall be measured to the outside of exterior walls (i.e., outside of brick, siding, stone, or stucco) and be included in the house square footage.)

### **(2) Site Plan**

Site Plan drawing including the following information:

- (a)** Section Number, Block Number, Lot Number
- (b)** Property Lines, Right of way, minimum setbacks & Easements
- (c)** Actual footprint of house and garage, with dimensions of main elements from property lines.
- (d)** Driveway, patios, walls and any other flatwork, fully dimensioned
- (e)** Locations of inlet(s)
- (f)** Total percentage of coverage of all impervious cover including house, garage, walkways, driveway, patios, porches, etc.
- (g)** Location, height, type and material of each exterior fence or wall.
- (h)** If applicable, any temporary construction facilities such as trailers, storage locations, fences, temporary Signs, lights, model home parking lots, etc.

## **5.4 Quality of Submission Content**

It is in the interest of both the Builders and the Developer that this process be a smooth and timely one. For that purpose, the approvals can be facilitated if complete and high-quality documentation is provided to the ARC. When an Application is received, it is reviewed for completeness. An Application that is not complete and/or not clearly readable will be returned (without review) with an explanation of the reasons for this action. A complete Application will be processed and reviewed by the ARC.

## **5.5 Submission Timing**

Submissions to the ARC for approval may be made at any time. Responses will generally be made within seven (7) business days from receipt of a completed online application (including all correct information, applicable supporting and required documents in electronic format), however a lack of response after ten (10) business days shall be deemed a rejection.

## 5.6 Submission Fees

- A. Nominal fees have been established by the Developer to help defray the expenses associated with the community-based review of improvements and inspections. These fees are adjusted from time to time and are based on the complexity of the project proposed as well as other factors. Payment for all submission review and inspection fees shall be made payable to the address listed below and list of current fees can be obtained from:

Carma Easton, LLC  
9600 N MoPac Expressway, Suite 750  
Austin, Texas 78759

- B. Builders shall make a single payment for all initial ARC reviews and inspections for each Lot at the time the builder closes on the Lot, which shall include:
- Builder Permit Review
  - Lot Ribbon Inspection
  - Final Compliance Inspection
- C. Builders shall make payment for Master Plan reviews at the time of submission.
- D. Builder shall make payment for any resubmission(s) and/or re-inspection(s) at the time of permit resubmission and/or re-inspection request.

## 5.7 ARC Action on Submittals

Notice of Approval, Conditional Approval or Disapproval of each submission will be returned to the Applicant via email or other electronic means which the ARC deems appropriate. Builder may request a Lot Ribbon Inspection immediately following receipt of written Final Building Permit Approval from the ARC. Approval by the ARC does not constitute an approval by any other entities.

## 5.8 Approval from Additional Entities

Applicant/Builder is solely responsible for obtaining all applicable written approvals from all applicable governing bodies, agencies, offices and/or entities. Approval by the ARC does not constitute an approval by any other entities.

## 5.9 Expiration of Permits

All approved or conditionally approved permits shall be exercised within one (1) year from the date of approval, or the permit shall be null and void.

## 5.10 Variances

Variances to these Guidelines may be granted by the ARC. Any variance granted will only be applicable to the specified site and conditions for which the variance was granted, only if it has been identified in writing on the submitted plan and specifically approved in writing by the ARC. Granting of such a variance will not modify or change any Guidelines as they apply to other Lots or conditions.

All variances shall be exercised within one (1) year from the date of approval or the variance shall be null and void. If an extension is needed, the Applicant/Builder must submit an application in writing, thirty (30) days prior to the expiration and for good cause, the ARC may grant an extension of time not to exceed one (1) year.

### 5.11 Construction Timeline

Construction of dwellings, which have received prior written approval or conditional approval by the ARC, shall commence within one (1) year of the permit date and shall be completed within one (1) year.

The ARC may grant an extension for construction on a case-by-case basis, but the request for an extension must be made at least thirty (30) business days prior to the conclusion of the completion deadlines noted above.

### 5.12 Inspection Procedures and Penalties

#### A. Lot Ribbon Inspection Procedures and Penalties (Including Builder Notice Signs)

A representative of the ARC must inspect the unimproved Lot, prior to any construction, to assess that the house and driveway layout and orientation have been properly ribboned (by the Builder's survey company) in conformance with the approved plans, permits and these Guidelines. The Builder is ultimately, solely responsible and solely liable for improvement of the Lot in conformance with the approved plans, permits and these Guidelines. No construction of any kind may be conducted without prior written approval from the ARC. Any improper and/or unauthorized construction on a Lot, at the Developer's sole discretion, may levy a two-hundred and fifty dollar (\$250) fine and twenty-five dollars (\$25) a day until construction ceases.

All Lots must have a Builder Notice Sign correctly displayed on the Lot from the time of the Lot Ribbon Inspection until final grading for Landscaping has started. At which time a permanent address plaque or numerals must be installed on the front elevation of the home.

Notice Signs are available, free of charge, at the Builder's Compound. For details please contact:

Brookfield Properties  
On-Site Construction Manager

Information about the Notice Sign and how to correctly fill it out is available on the "Survey Ribboning & Builder Notice Sign before a Lot Ribbon Inspection" guide referenced below.

*(Reference the online guide: "Survey Ribboning & Builder Notice Sign before a Lot Ribbon Inspection" available at [www.KenAnderson.com](http://www.KenAnderson.com) > Residential > Easton Park.)*

#### B. Final Compliance Inspection Procedures, Penalties, and Variances

A representative of the ARC must inspect the improvements to verify that they have been constructed in conformance with the ARC approved plans and these Guidelines. The Final Compliance Inspection represents a selected portion of these Guidelines; it should not be considered as a total approval of these Guidelines. Inspections conducted by the ARC's assigned representative are aesthetically based only and in no way, include inspections pertaining to code compliance or to the integrity of the home and/or improvements. Builders are solely responsible and solely liable for ensuring that all construction and/or improvements meet or exceed all applicable codes, good building practices and comply with all local and federal regulations, laws, etc. Each builder is ultimately responsible to make sure every home is built to be in full compliance with these Guidelines.

This Final Compliance Inspection does not constitute review, inspection or approval by any other applicable governing bodies, agencies, offices and/or entities, which Applicant/Builder is solely responsible for obtaining.

**(1) Request for Initial Final Compliance Inspection**

Once a home is completed, each Builder is solely responsible for making a request to the ARC for a Final Compliance Inspection, using the online request services at [www.KenAnderson.com](http://www.KenAnderson.com) > [Residential](#) > [Easton Park](#). Request for a Final Compliance Inspection must be made at least seven (7) days before the home closes.

A final survey (including all fences, pools and other installed improvements) must be submitted to the ARC at the time the Final Compliance Inspection request is made. Anyone who fails to meet the requirements will be subject to a two-hundred and fifty (\$250.00) dollar fine, which may be deducted from the Builder's construction deposit and/or damage deposit.

If the property does not pass its initial Final Compliance Inspection, the builder will have fourteen (14) days to correct all items listed on the Final Compliance Inspection report. It is the builder's sole responsibility to request a re-inspection once the necessary corrections have been completed otherwise a re-inspection will be conducted automatically after the fourteen (14) days have expired.

**(2) 2nd Final Compliance Inspection (Re-Inspection)**

If the property does not pass its 2nd Final Compliance Inspection, the builder will have fourteen (14) days to correct all items listed on the Final Compliance Inspection report. It is the builder's responsibility to request a re-inspection once the necessary corrections have been completed otherwise a re-inspection will be conducted automatically after the fourteen (14) days have expired.

If home is closed prior to re-inspection and the inspector needs access to areas of the property behind the front fence, the builder must acquire written approval from homeowner to allow ARC representative to access the exterior property to conduct inspection.

**(3) 3rd Final Compliance Inspection (Re-Inspection)**

The property will be inspected one (1) final time. If all outstanding items have not been corrected, the following may occur:

- (a)** The builder will be issued a Final Compliance Inspection verdict of "Closed Non-Compliant" and a copy will be sent to the HOA.
- (b)** All New Construction Submittals/Building Permits (starts) may be put on hold company-wide until all outstanding inspection items are brought into compliance.
- (c)** Responsibility for bringing all outstanding items into compliance will transferred from the builder to the Homeowner and resolution may be enforced through the HOA as a request to comply with these Guidelines.
- (d)** When necessary the HOA will inform the Homeowners that the home was inspected multiple times to allow the builder to bring the outstanding items into compliance, and that it was the Builders sole responsibility to make sure that all construction requirements were met before the home closed.

**5.13 Remedies**

Additional remedies and enforcement rights may exist under the Covenants. The ARC and/or HOA may file suit to obtain an injunction mandating compliance with the Covenants and the Guidelines. The ARC and/or HOA has the further right, after proper notice to the Owner, to go onto the property where a violation exists, fix or remove the violation, and collect any costs incurred from the Owner.

#### **5.14 Changes in Review Process**

The ARC reserves the right to alter the review process in order to ensure an adequate review of all submissions while reasonably accommodating the needs of Applicants/Builders.

#### **5.15 Governmental Regulations**

The Covenants and these Guidelines are not intended to permit any action prohibited by applicable laws, rules, or regulations of any governmental authority. Where these Guidelines contain requirements in addition to or more restrictive than applicable governmental laws or regulations, the provisions of these Guidelines are binding and enforceable, and prevail over the requirements of such laws or regulations unless these Guidelines are expressly made unenforceable by law or judicial decisions.

#### **5.16 Job Site Procedures**

##### **A. Trash Containment**

All Lots under construction are required to have two (2) forms of trash receptacles on each lot ("Type A" & "Type B"). They must be kept on site and maintained during the construction process.

##### **(1) Type A**

Refers to a trash bin that will be used to contain trash material that will most likely be wind-blown from the construction of the home. This material includes, but is not limited to shingles, insulation, a/c ducts, and mortar bags. Material such as interior trim and tile will also be placed in this trash bin.

The three (3) sided trash bin will have an eight by eight (8' x 8') footprint and be made up of four foot by eight foot (4' x 8') (natural or black painted) solid wood material panels. The open side must always face the front of the house, away from the street. On Corner Lots this trash bin must be four (4) sided.

Heavy material such as lumber and brick should be placed in a single pile on the Lot under construction. Any additional small debris left over after trash pick-up should be placed in a trash bin. No random material should be left out around the house.

##### **(2) Type B**

Refers to a trash bin that will be used to contain trash from labor and trade personnel working on the job site (plates, cans, food trash, etc.). This trash bin will be a fifty-gallon (50) plastic drum or similar product that functions in the same capacity. Daily clean up food trash is required in order to reduce the amount of trash that is blown into the streets and neighborhood.

Each builder is solely responsible for enforcing the daily clean-up of food trash and making sure that all construction trash around the house is contained.

##### **B. Concrete Washout**

All concrete washouts shall be either wood formed and lined with tarp or Eco Pan (or Eco Pan equivalent) on a Lot which the Builder owns. Additionally, concrete washouts should be located (whenever possible) on Lots which have low traffic and/or visibility to the general public. Concrete washouts shall not be located on Corner Lots and shall have an erosion barrier installed and maintained solely by the Builder at all times. A Builder Notice Sign is required on Lots with concrete washouts. Each builder is solely responsible to ensure that all washout construction shall comply with TCEQ and EPA requirements.



**C. Silt/Mud in Street**

Each builder is solely responsible for ensuring that every Lot under construction has a silt fence installed along the entire street facing portion of the Lot and have at least two (2') foot returns at termination points. One (1), sixteen (16') foot maximum width access point may be utilized (generally the future driveway location), which must employ a proper erosion barrier, such as: rip-rap, wood chips, etc.

Unacceptable erosion barriers at access points include, but are not limited to: Curlex, sod, sandbags and back-cutting the dirt directly behind the curb.

All erosion barriers must be maintained and any silt or mud that develops must be removed immediately whenever possible and no later than the end of construction hours for that day.

Each builder is also solely responsible for repairing any silt fence that is damaged on an adjacent Lot during construction. This also includes the removal of any dirt or mud that accumulates in the street from access to a home under construction via an adjacent Lot.

Erosion barriers must meet or exceed minimum requirements of all applicable governing bodies, agencies, offices and/or entities.

**D. Damage to Common Areas and/or Cul-de-Sac Island(s)**

The builder is solely responsible for any damages incurred on the common areas and or cul-de-sacs sustained by the builder and/or their subcontractors or delivery trucks. This includes, but is not limited to ruts, planting damage, curb damage and/or irrigation damage. The builder will either be asked to replace or repair the damaged material or be billed for any damages.

**E. Lot Mowing**

Each builder is solely responsible for ensuring that the Lots they own are maintained and mowed on at least a monthly basis or as necessary as determined by the ARC and/or the Developer.

*(The remainder of this page is left blank intentionally.)*

## **VI. Exhibits & Diagrams**

All exhibits & diagrams will be found on the pages that follow.



The Craftsman style of architecture results in natural, warm, livable buildings characterized by horizontal forms and simple shapes.

This style remains popular due to its timeless feel, but is not considered traditional. Roofs are gently pitched gables (occasionally hipped) with wide, unenclosed eave overhangs.

Exposed, extended, or elaborated roof rafters may also be used. Dormers are usually gabled or shed.



STYLE ELEMENTS	ARCHITECTURAL FEATURES
Building Masses	One, one and a half, and two story massing.
Roofs	Low to moderately pitched, gable or shed dormers, clipped gables with shake siding.
Porches	Integral part of house, tapered columns with brick/stone base, exposed truss at porch entry.
Chimneys	Natural or dressed stone exposed or centered within structure.
Windows	Divided grids/panes, grids in upper portion of window, vertical proportions, projecting bays (without angles) extending to foundation, boxed windows.
Entry Doors	Entry door with glazing on upper part of door.
Garage Doors	
Details	Knee bracing or other bracket detailing at top of column, exposed, extended or elaborated rafter tails, contrasting color on trim, fascia, post and exposed beams, decorative trim at windows and doors, V-groove siding as porch ceiling treatment.
Materials	Brick or stone as foundation finished material, brick or stone wainscot.
Colors	Reference "Color Scheme Examples" Exhibit(s).
Other	



Mid-Century Modern homes were designed to be the forward-looking style of their time. Its design integrates the principles of organic architecture with elements of the International Bauhaus movement.

The charm of these houses, created by simplistic linear forms and low-sloping roofs, has recently emerged back into the design world and become a popular design style.

Mid-Century Modern emphasizes on creating structures with ample windows and open floor-plans with the intention of opening up interior spaces an bringing the outdoors in.

Many Mid-century homes utilized a post and beam structural design which eliminates the bulky support walls in favor of walls seemingly made of glass.

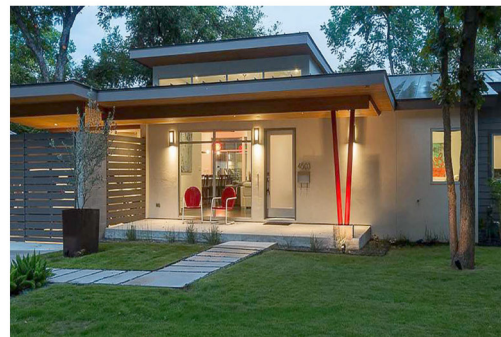

STYLE ELEMENTS	ARCHITECTURAL FEATURES
Building Masses	One and two story massing, flat planes, geometric lines, structural transparency, post and beam architecture.
Roofs	Flat and low sloping gable roofs.
Porches	Large vaulted porch, steel porch columns.
Chimneys	Design compatible with house design.
Windows	Large windows allowing light from multiple angles, geometric transom windows, metal awnings over windows.
Entry Doors	Glass entry door.
Garage Doors	Simple, linear form, wood or metal.
Details	Exposed beams from inside of house out to overhang.
Materials	Brick stone accents, tile accents as an exterior material, mixture of exterior materials, lap siding/board and batten.
Colors	Reference "Color Scheme Examples" Exhibit(s).
Other	Large back patio with indoor/outdoor relationship.





Contemporary house design integrates a wide number of style features. It melds historic elements with current lifestyle concepts, resulting in homes that are warm, inviting and connected with the outdoors.

Key features of a contemporary house design include irregular or asymmetrical facade, strong geometric shapes, extensive use of natural light, open floor plan to embrace outdoor space, clerestory windows, and varies from one to two stories.



STYLE ELEMENTS	ARCHITECTURAL FEATURES
Building Masses	One and two story massing.
Roofs	Multiple low roof lines at different levels, wide overhangs, metal roofs.
Porches	Porch entry area with warm wood tones, flat roof and natural light above it, steel tubular columns, V-groove siding at ceiling.
Chimneys	Design compatible with house design.
Windows	Fixed, casement or awning windows with integrated window overhangs, clerestory windows following the roof lines.
Entry Doors	Solid glass or contemporary entry door.
Garage Doors	Garage door with geometric paned glass panels.
Details	Contrasting exterior colors (light stone with dark roof or vice versa).
Materials	Mixture of stone (clean cut) and stucco with wood accents, metal siding accents.
Colors	Reference "Color Scheme Examples" Exhibit(s).
Other	Use of parapet walls and asymmetrical design/metal, indoor/outdoor living at back porch.



The modern farmhouse is a contemporary play on a traditional design. It evokes a nostalgic feeling of warmth and comfort of days-past by reshaping it with clean lines and simple materials for a fresh design.

Homes are typically one and two story dwellings with distinct elements such as oversized openings, light walls, gabled roofs and large porches and patios.



STYLE ELEMENTS	ARCHITECTURAL FEATURES
Building Masses	One and two story massing.
Roofs	Sheet metal roof, exposed rafter tails, street/side facing gable, shed or gable dormers, gables.
Porches	Front porch wraps around to side for veranda view, designed to allow for indoor/outdoor living, V-groove siding at porch ceiling, open truss at porch entry area.
Chimneys	Design compatible with house design.
Windows	Large, minimal 1-2 panes per sash or fixed window, integrated window overhangs (complimentary to roof design), metal awnings with metal brackets.
Entry Doors	Double or wider door with multi-paned glass accents on each door.
Garage Doors	Glass panel (frosted or opaque) accents in garage door.
Details	Clean, simple lines and shapes.
Materials	Vertical siding on all sides, horizontal siding as accents to add balance, metal or stone accents.
Colors	Reference "Color Scheme Examples" Exhibit(s).
Other	Columns generally square, simply detailed, flat roof/arbor at covered patio at rear, raised plate heights at front elevation with single story flat porch/transoms above porch roof area.





The Prairie house plan is a uniquely American architectural style. Massive square or rectangular piers of masonry used to support porch roofs are an almost universal feature of high-style examples.

Other common details include window boxes or flattened pedestal urns for flowers, geometric patterns of small-pane window glazing, broad, flat chimneys, contrasting wall materials or trim emphasizing the upper part of the upper story, and decorative friezes or door surrounds consisting of bands of ornamentation.



STYLE ELEMENTS	ARCHITECTURAL FEATURES
Building Masses	Solid Construction, one- and two-story massing, one-story projections. Building form is linear and low.
Roofs	Flat or hipped roofs with broad eaves.
Porches	Broad covered porches with square columns, sometimes with brick or stone bases.
Chimneys	Natural or dressed stone exposed, central chimney.
Windows	Windows assembled in horizontal bands, often with well-defined vertical detail subtly mimicking Japanese shoji screens.
Entry Doors	Hinged double doors, solid wood as well as glass, lights on sides of doors.
Garage Doors	Natural wood. solid, contemporary horizontal windows, all glass.
Details	Restraint in the use of decoration, broad overhanging eaves, symmetrical with subordinate wings or porches, floral and circular geometric forms and angular geometric designs, exposed rafters.
Materials	Strong horizontally-oriented facades.
Colors	Reference "Color Scheme Examples" Exhibit(s).
Other	Usually marked by its integration with the surrounding landscape.



Homes built in the Texas Vernacular style feature simplified entries, often tucked under wide porches with deep overhangs.

Simple shapes form the massing of the home with low pitched roofs featuring dark, earth toned shingles or metal standing seam roofing.

Stone is prominent in the facade and is often paired with stucco finishes or vertical board & batten siding.

Windows are proportioned vertically and are often accompanied by cedar brackets. Cedar details and accents are plentiful, though ornamentation is otherwise limited.



STYLE ELEMENTS	ARCHITECTURAL FEATURES
Building Masses	Simple forms and massing.
Roofs	Composite shingle roofing in black or brown tones, metal roofing, exposed rafter tails and brackets are common under roof eaves in natural wood / cedar. Typical pitch includes 3:12 and 8:12.
Porches	Deep, full wide porches and verandas are encouraged, porch posts are square.
Chimneys	Chimneys are important elements in building massing and should be designed as an architectural main feature.
Windows	Windows are vertical in proportion, bay windows are common.
Entry Doors	Simple entryway.
Garage Doors	Garage door has minimal glazing, however it requires hardware.
Details	Decorative brackets.
Materials	Stone and stucco are incorporated into the siding, stone should be 50% of the front facade. Cedar/wood accents, shutters with hardware.
Colors	Exterior colors are often shades of brown or earth tones. Reference "Color Scheme Examples" Exhibit(s).
Other	Natural material for columns and posts (cedar or other wood), columns utilize post and lintel construction.





Colonial-style homes are generally symmetrical or square, with steep roofs and feature an centralized front door with a formal entry or porch.

The style also features two windows on either side of the entry door. Greek or Roman style columns are typically a prominent featured on the entry porch and windows are symmetrically placed on both sides of the front door.

Windows are usually accompanied with proportional shutters (*each shutter covers half of the window*) and are double-hung with multi-pane sashes.



STYLE ELEMENTS	ARCHITECTURAL FEATURES
Building Masses	One and two story massing. Gable front and wings.
Roofs	Side-gabled roof, hipped roof, centered gable, asymmetrical, hipped roof with full-width porch.
Porches	Four columns is most common, even spacing.
Chimneys	Natural or dressed stone exposed, central chimney.
Windows	Palladian-style window in the second story over the main entrance; the use of flat or keystone lintels above the windows with prominent sills below. Elliptical, half-circular, or Palladian windows are sometimes used on side or front gables; dormers typically have arched windows. Double hung sash windows placed singly but in symmetrical rows. Fixed upper sashes and movable lower sashes. Sometimes have elaborate decorative crowns placed above windows. Rectangular windows are common.
Entry Doors	Accentuated front door which often includes an entry porch. Decorative detailing on door surrounds. Fanlight above entry door. Door surrounds. Bold front door color..
Garage Doors	Garages facing the street deaden the public space; rear garages accessed from the alley or a front drive are ideal.
Details	Roof-line balustrades. Front stair rails of iron. Iron balconies and curved front bays. Decorative detailing around entry porch, over windows, along the cornice. Cornices. Shutters.
Materials	Horizontal hardi-siding and brick accents, shingles. Stucco and stone occur infrequently.
Colors	Reference "Color Scheme Examples" Exhibit(s).
Other	Greek or Roman columns.



Transitional homes combine traditional and modern styles to create a cohesive and clean feel, facilitating modern living. Lack of ornamentation and decoration keeps focus on the architecture.

Widely used features include dormers, shallow porches, tall entries often two stories in height, and complex roof forms.

Exterior wall cladding materials are often intermixed. Rear facades offer full interaction with backyards and views through large windows, complete window walls, porches, balconies, decks and terraces.



STYLE ELEMENTS	ARCHITECTURAL FEATURES
Building Masses	One and two story massing.
Roofs	Hip roof with gable off of the front, street facing gable, gable dormers.
Porches	Not the main element of this style.
Chimneys	Design compatible with house design.
Windows	Large window, bottom sash window usually 1 light, one over one window lights.
Entry Doors	Traditional Solid Panel / Wood.
Garage Doors	Glass panel accent in garage door.
Details	Clean simple lines and shapes, clean brackets.
Materials	Horizontal siding and brick accents.
Colors	Follow Contemporary + Modern Color Scheme. Reference "Color Scheme Examples" Exhibit(s).
Other	Hardy wrapped columns and generally square and simply detailed.





Originating in the late 1800's, the Victorian style is known for its charming ornamental detailing and bright colors.

The Victorian Era marked the explosion of creative options and the emergence of intricate, daring forms and techniques available to the homeowner as never before.

The combination of exposed trusses, brackets, spindles, scrollwork, and many other details are what create such a unique character for the Victorian style home.



STYLE ELEMENTS	ARCHITECTURAL FEATURES
Building Masses	One, one and a half, and two story homes.
Roofs	Metal Roof, moderate 12-16" overhangs with rake soffit, embellished trusses at gable apex, concrete tile/slate roof, box outs with hip roof.
Porches	Circular wrap around porch, decorative moulding/brackets, decorative ceiling treatment (fur-downs with V-groove siding at inset), decorative wood railing.
Chimneys	Design compatible with house design.
Windows	Decorative windows (diamond, oval shaped, or arched accent windows), tower elements and bay windows.
Entry Doors	
Garage Doors	
Details	Decorative moulding at boxed soffit, decorative columns, decorative trim, thick frieze board with dental trim.
Materials	Predominantly lap siding with scallop/shake siding at gables or accent material, square brick or stone columns.
Colors	Reference "Color Scheme Examples" Exhibit(s).
Other	Decorative brackets/bracing at gable ends.

## Modern / Contemporary - Color Palette



BODY					
TRIM					
ACCENT					

## Craftsman - Color Palette



BODY					
TRIM					
ACCENT					

### Mid-Century Modern - Color Palette



BODY					
TRIM					
ACCENT					

### Modern Farmhouse - Color Palette



BODY					
TRIM					
ACCENT					



Modern Prairie - Color Palette



BODY					
TRIM					
ACCENT					

Texas Vernacular - Color Palette



BODY					
TRIM					
ACCENT					
STONE					

Traditional - Color Palette



BODY					
TRIM					
ACCENT					

Transitional - Color Palette



BODY					
TRIM					
ACCENT					

Victorian - Color Palette



	1	2	3	4	5
BODY	[Olive Green]	[Mustard Yellow]	[Taupe]	[Teal]	[Mauve]
TRIM	[Dark Brown]	[Dark Red]	[Light Tan]	[Rust]	[Grey-Blue]
ACCENT	[Brown]	[Dark Green]	[Orange]	[Light Brown]	[Light Grey]



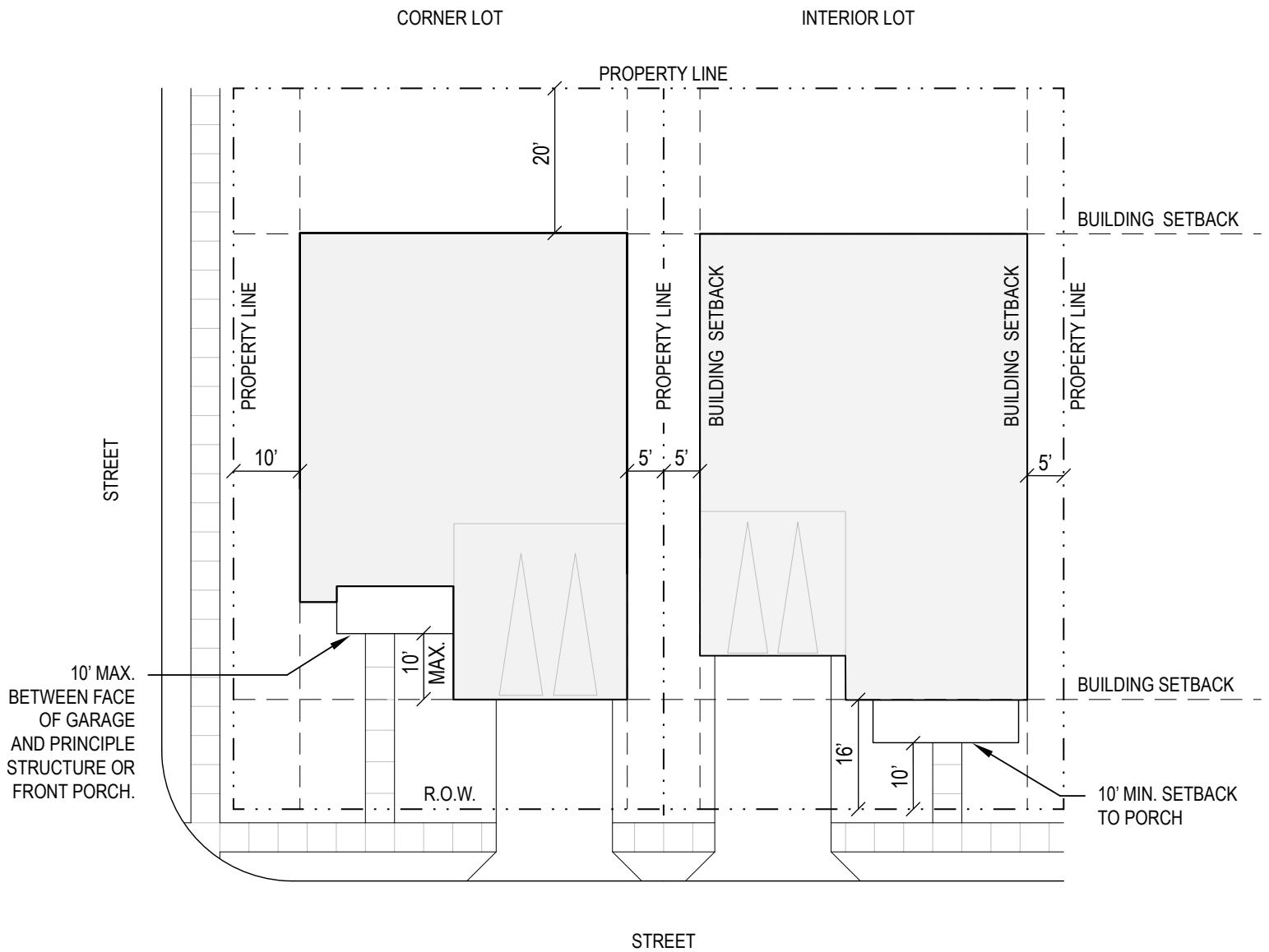

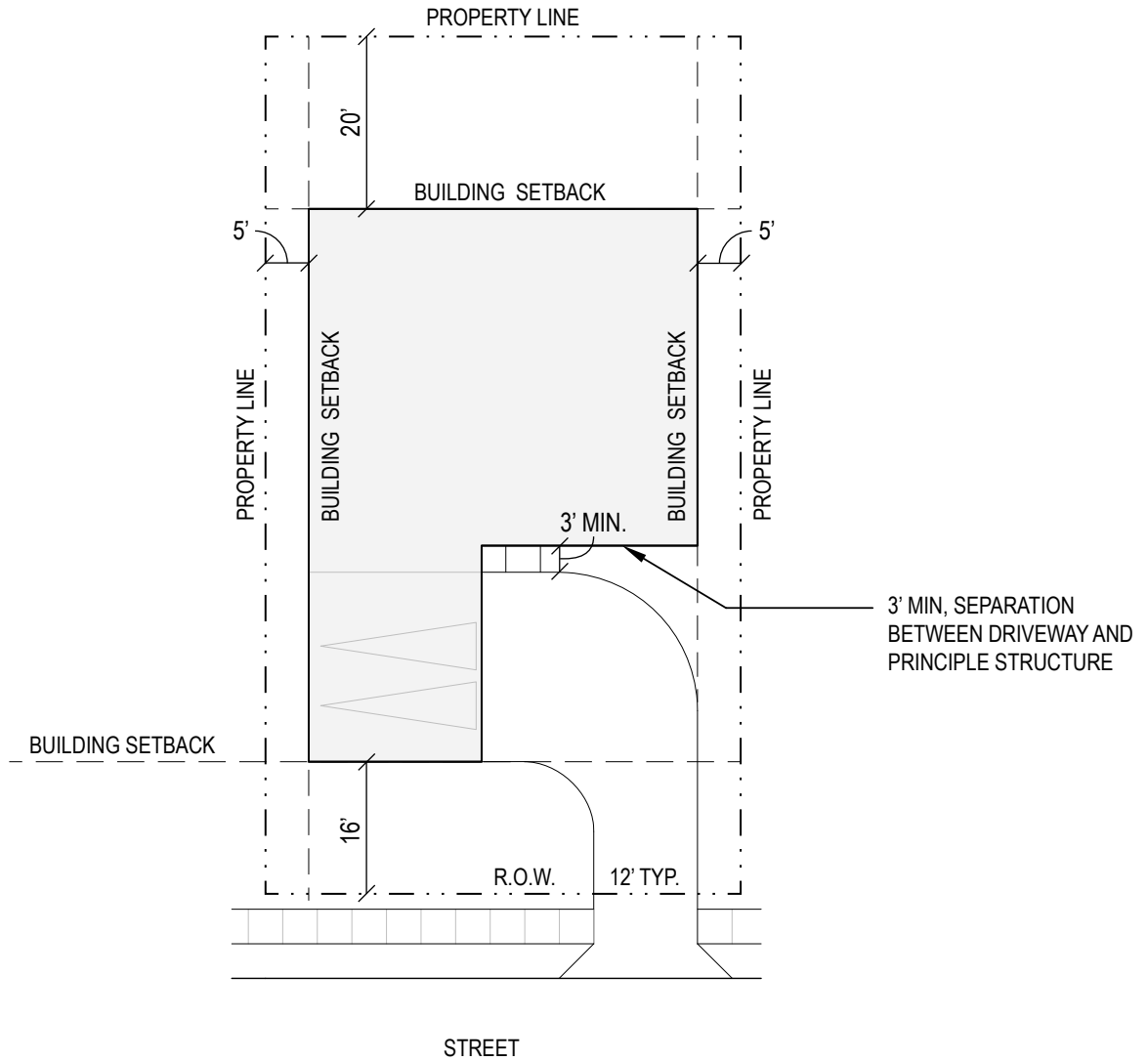

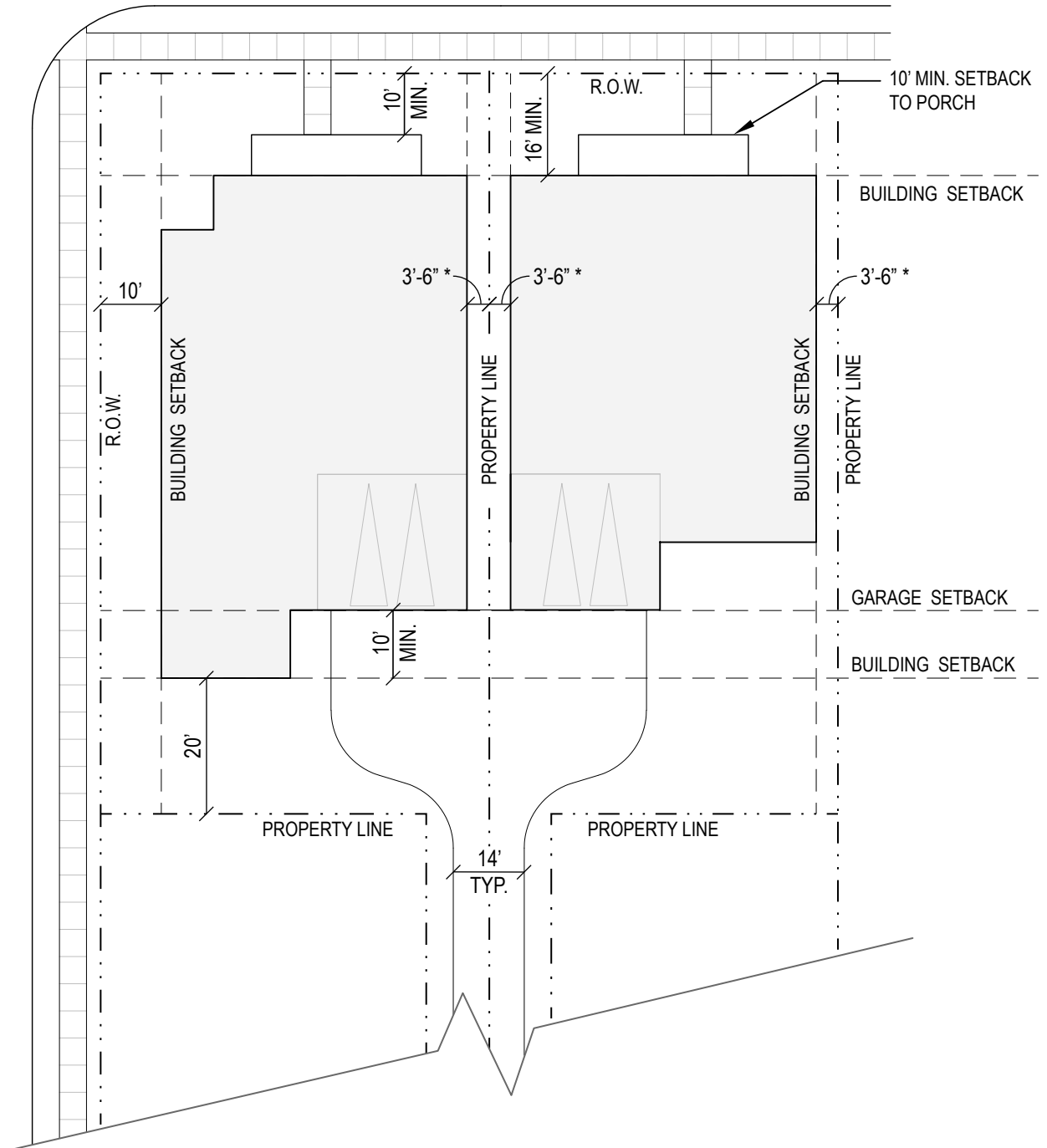

\*A HOUSE MAY BE SHIFTED TO THE INTERIOR PROPERTY LINE (MAKING IT A ZERO LOT LINE) IF:

1. THE BUILDER ALSO OWNS THE ADJACENT AFFECTED LOT; AND
2. THE ADJACENT HOUSES MAINTAIN A MINIMUM OF SEVEN (7') FEET OF SEPARATION BETWEEN THEM.

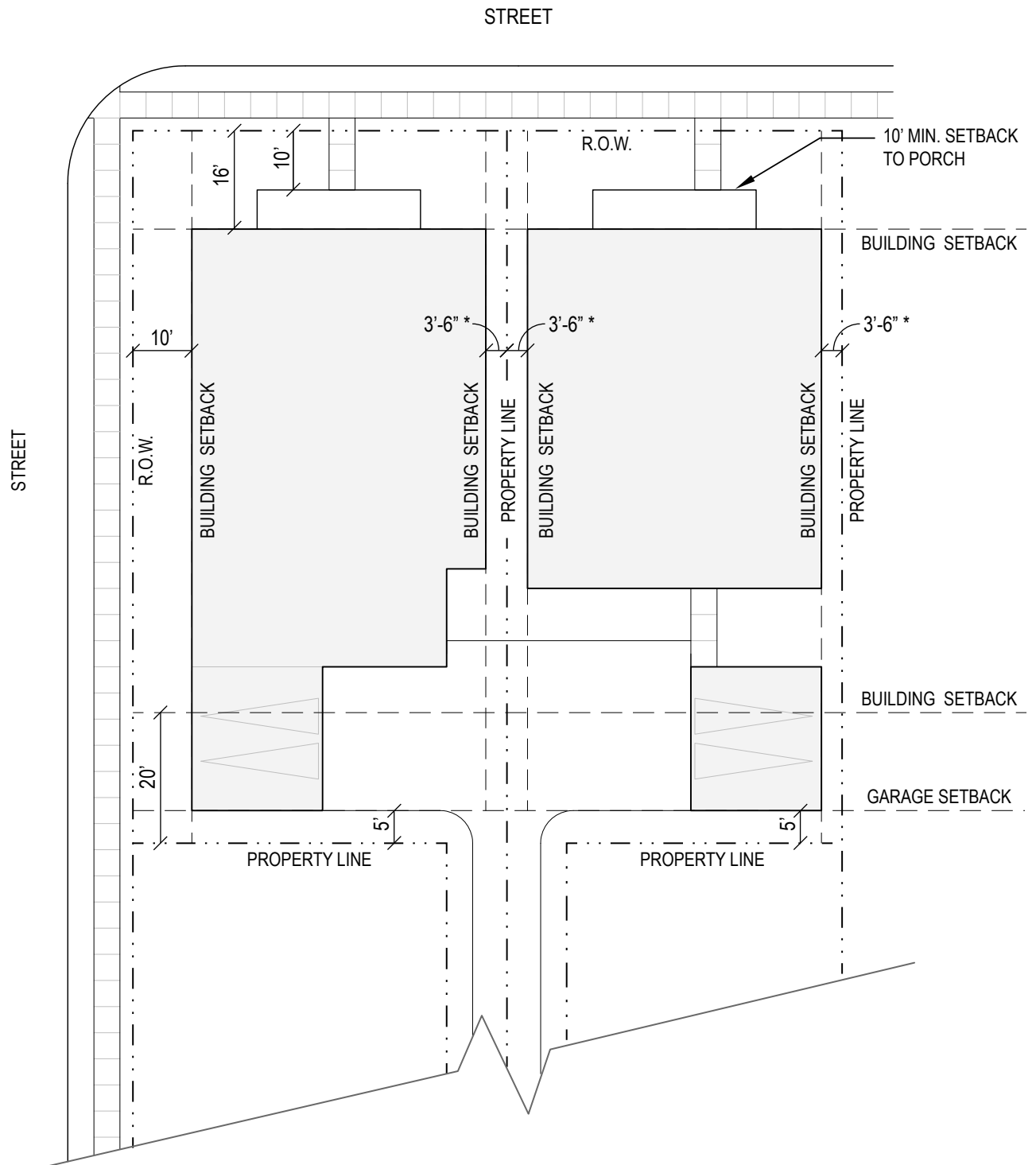

\*A HOUSE MAY BE SHIFTED TO THE INTERIOR PROPERTY LINE (MAKING IT A ZERO LOT LINE) IF:

1. THE BUILDER ALSO OWNS THE ADJACENT AFFECTED LOT; AND
2. THE ADJACENT HOUSES MAINTAIN A MINIMUM OF SEVEN (7') FEET OF SEPARATION BETWEEN THEM.

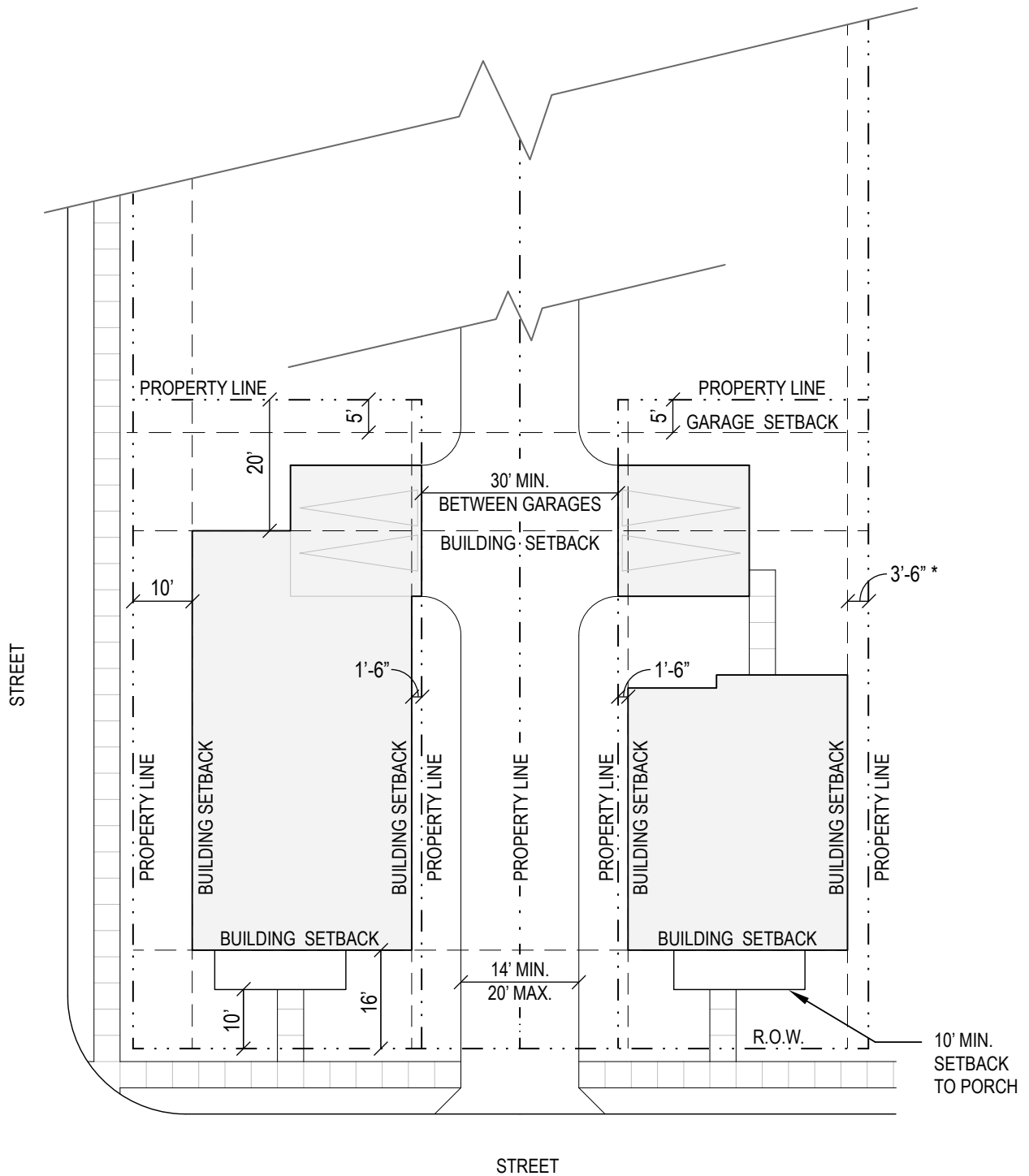

\*A HOUSE MAY BE SHIFTED TO THE INTERIOR PROPERTY LINE (MAKING IT A ZERO LOT LINE) IF:

1. THE BUILDER ALSO OWNS THE ADJACENT AFFECTED LOT; AND
2. THE ADJACENT HOUSES MAINTAIN A MINIMUM OF SEVEN (7') FEET OF SEPARATION BETWEEN THEM.

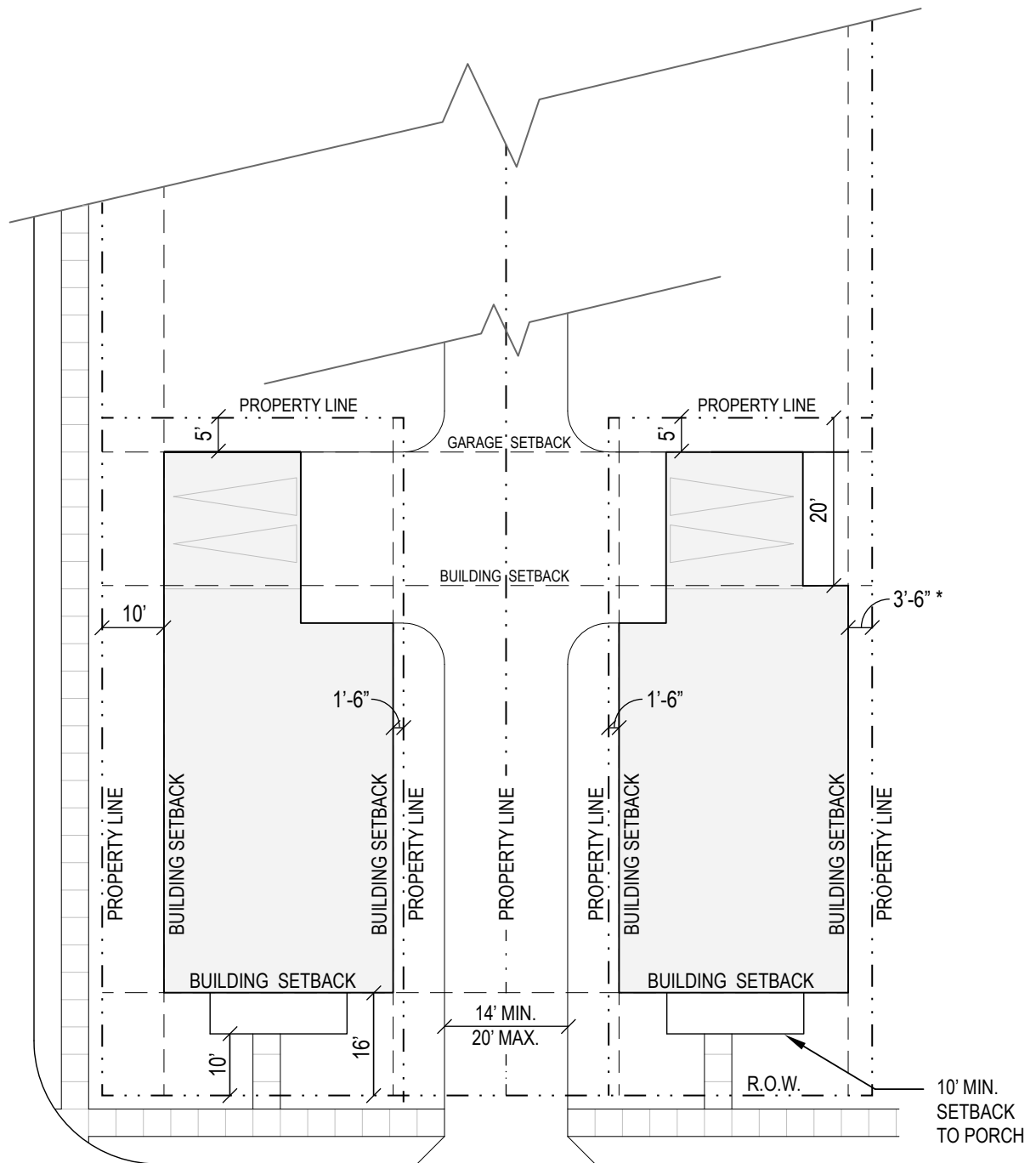

\*A HOUSE MAY BE SHIFTED TO THE INTERIOR PROPERTY LINE (MAKING IT A ZERO LOT LINE) IF:

1. THE BUILDER ALSO OWNS THE ADJACENT AFFECTED LOT; AND
2. THE ADJACENT HOUSES MAINTAIN A MINIMUM OF SEVEN (7') FEET OF SEPARATION BETWEEN THEM.

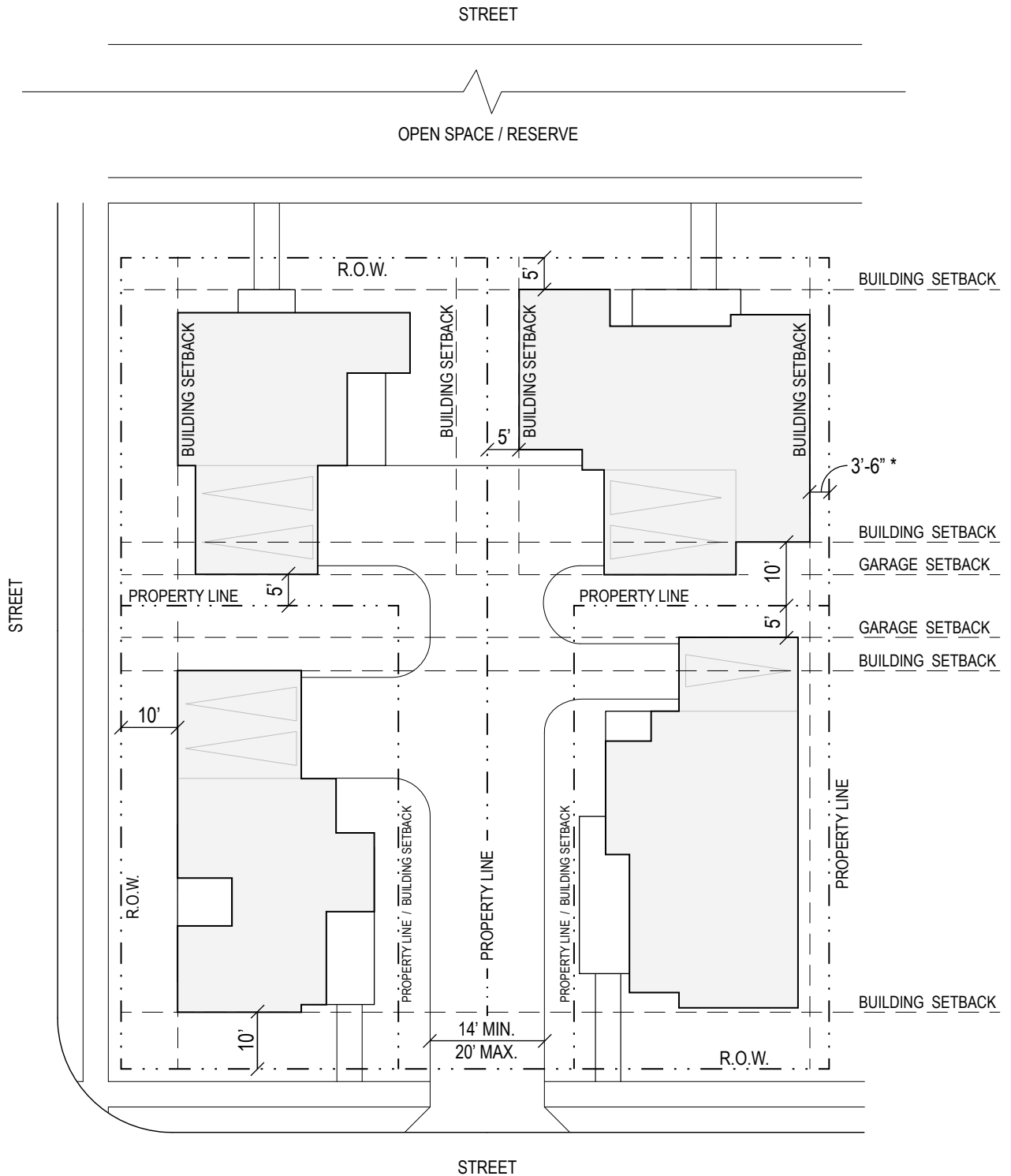

\*A HOUSE MAY BE SHIFTED TO THE INTERIOR PROPERTY LINE (MAKING IT A ZERO LOT LINE) IF:

1. THE BUILDER ALSO OWNS THE ADJACENT AFFECTED LOT; AND
2. THE ADJACENT HOUSES MAINTAIN A MINIMUM OF SEVEN (7') FEET OF SEPARATION BETWEEN THEM.

FENCE DETAIL: 6' WOOD, GOOD NEIGHBOR

SCALE: NTS

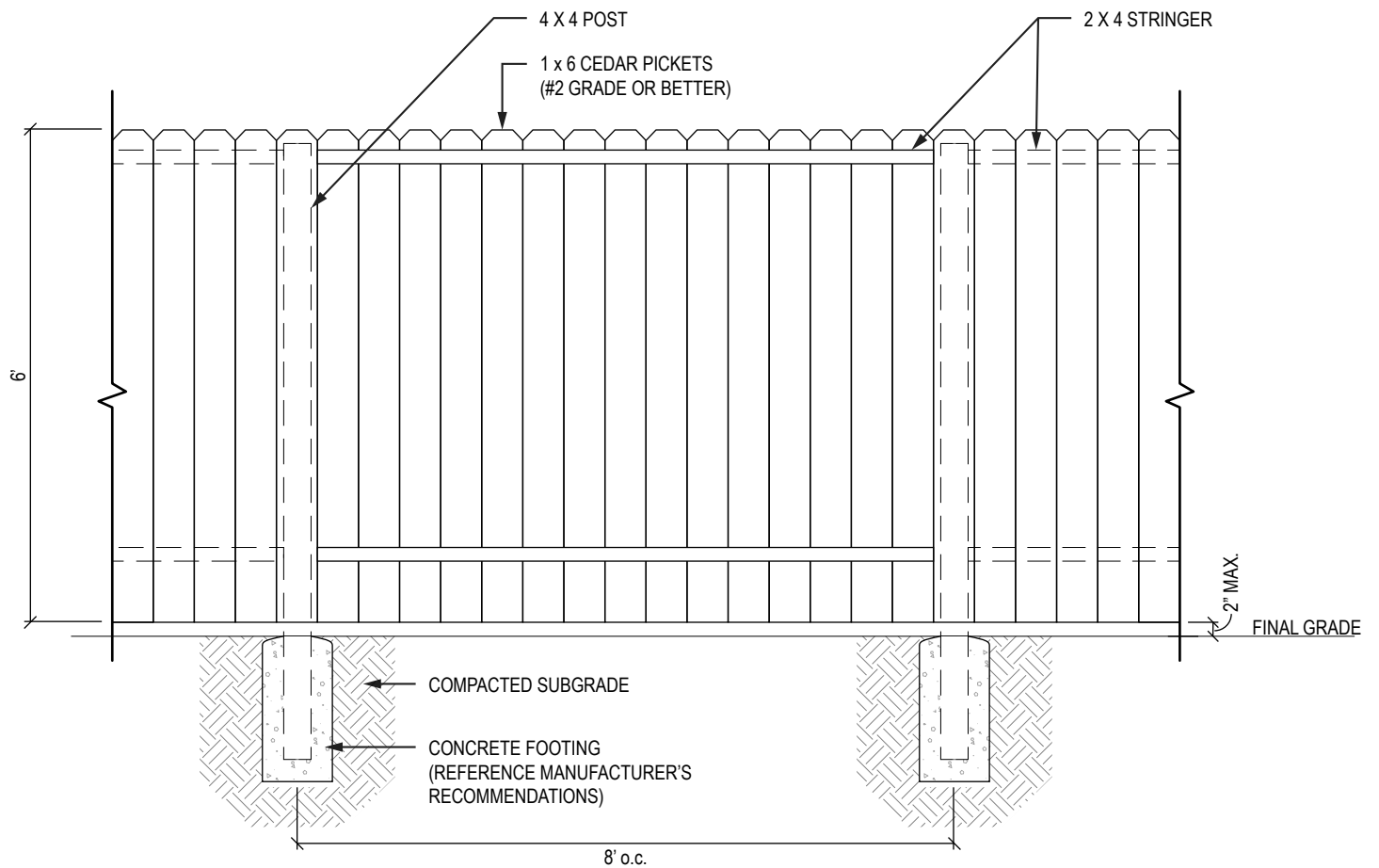
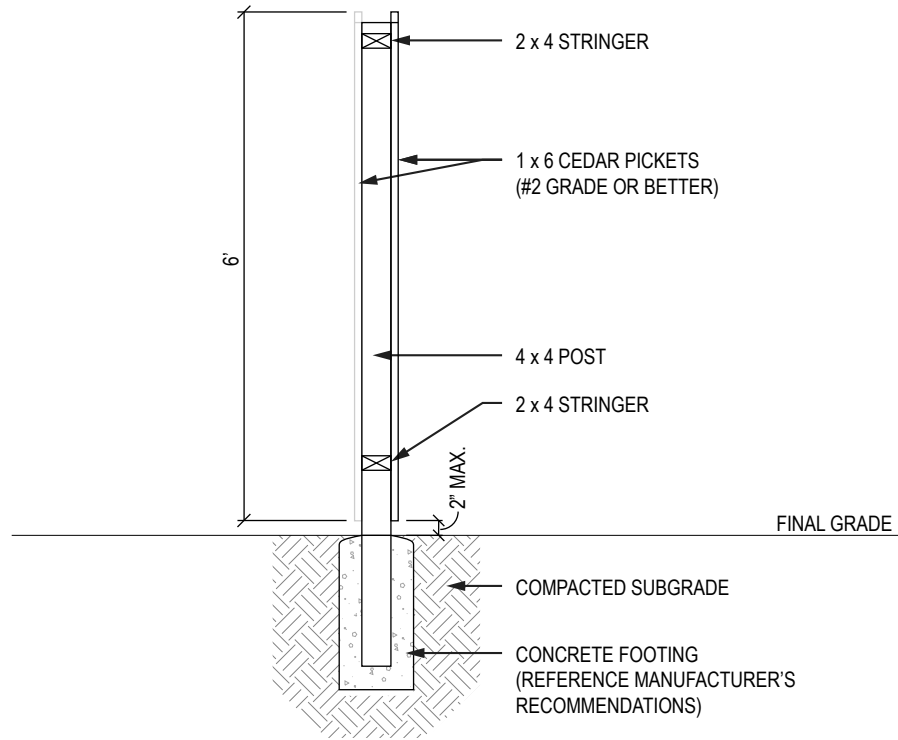



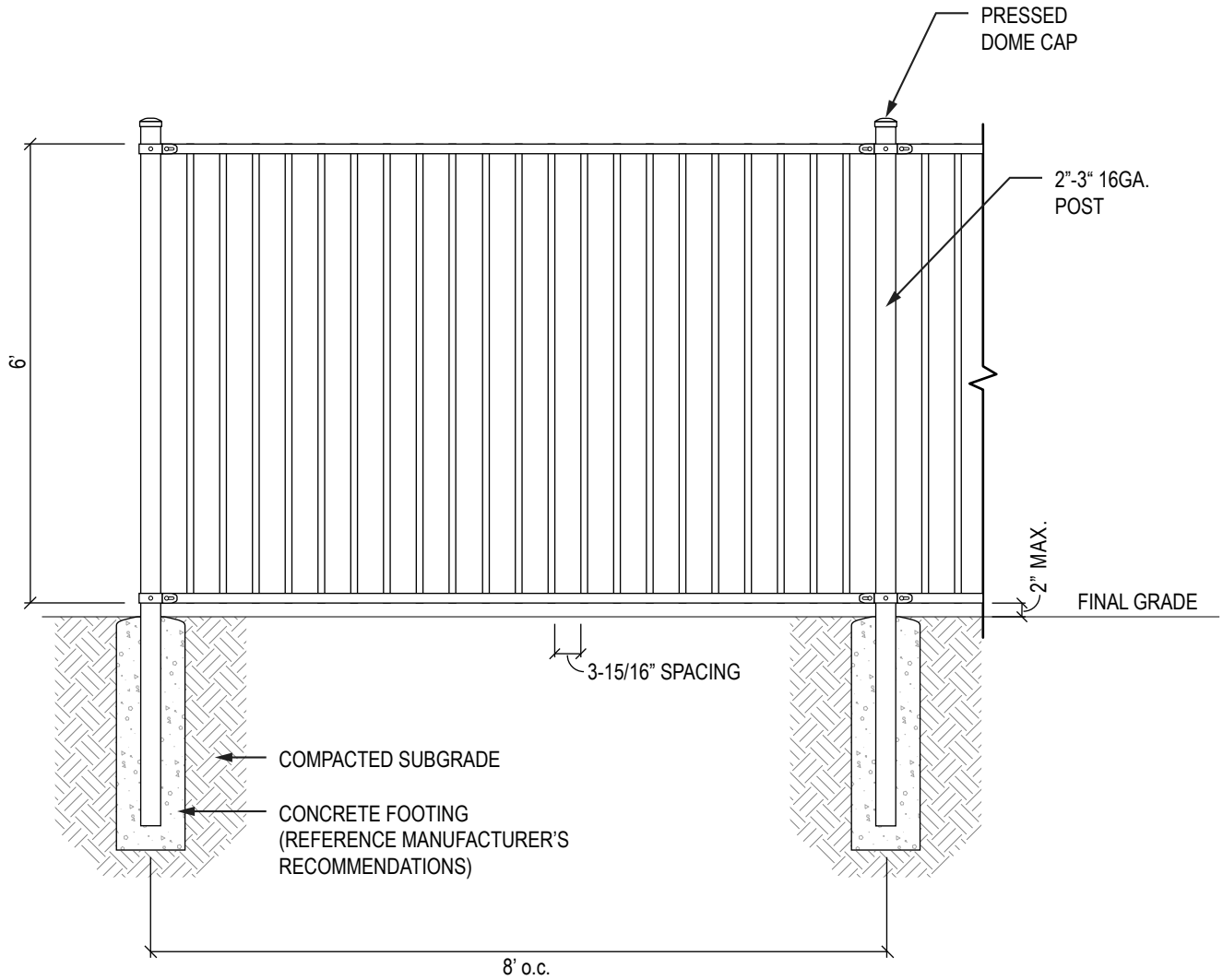

NOTES

1. ALL FENCES SHALL BE POOL BARRIER COMPLIANT.
2. ALL METAL FENCING WILL BE OF A MANUFACTURED PRODUCT THAT USES PRE-GALVANIZED STEEL WITH A ZINC RINSE AND A BLACK POWDER COAT FINISH. ALL METAL FENCING WILL BE OF A DESIGN THAT ALLOWS IT TO EASILY ACCOMMODATE CHANGES IN ELEVATION BY USE OF A RACKABLE SYSTEM.
3. ALL METAL FENCING WILL HAVE A FLUSH MOUNT RAILS (FLAT TOP, FLAT BOTTOM). ALL METAL FENCING WILL HAVE A MINIMUM TWENTY (20) YEAR MANUFACTURER WARRANTY.
4. CERTAIN METAL FENCES WILL BE INSTALLED BY THE DEVELOPER. (REFERENCE "SECTION FENCE & DRIVEWAY LAYOUTS" AVAILABLE ONLINE AT [WWW.KENANDERSON.COM](http://WWW.KENANDERSON.COM) > RESIDENTIAL > EASTON PARK.

FENCE DETAIL: 6' WOOD, GOOD NEIGHBOR SHARED SIDE FENCE WITH 6' METAL FRONT FENCES  
(SOLID PICKET RETURN - OFFSET NEIGHBORING FRONT FENCES)

SCALE: NTS

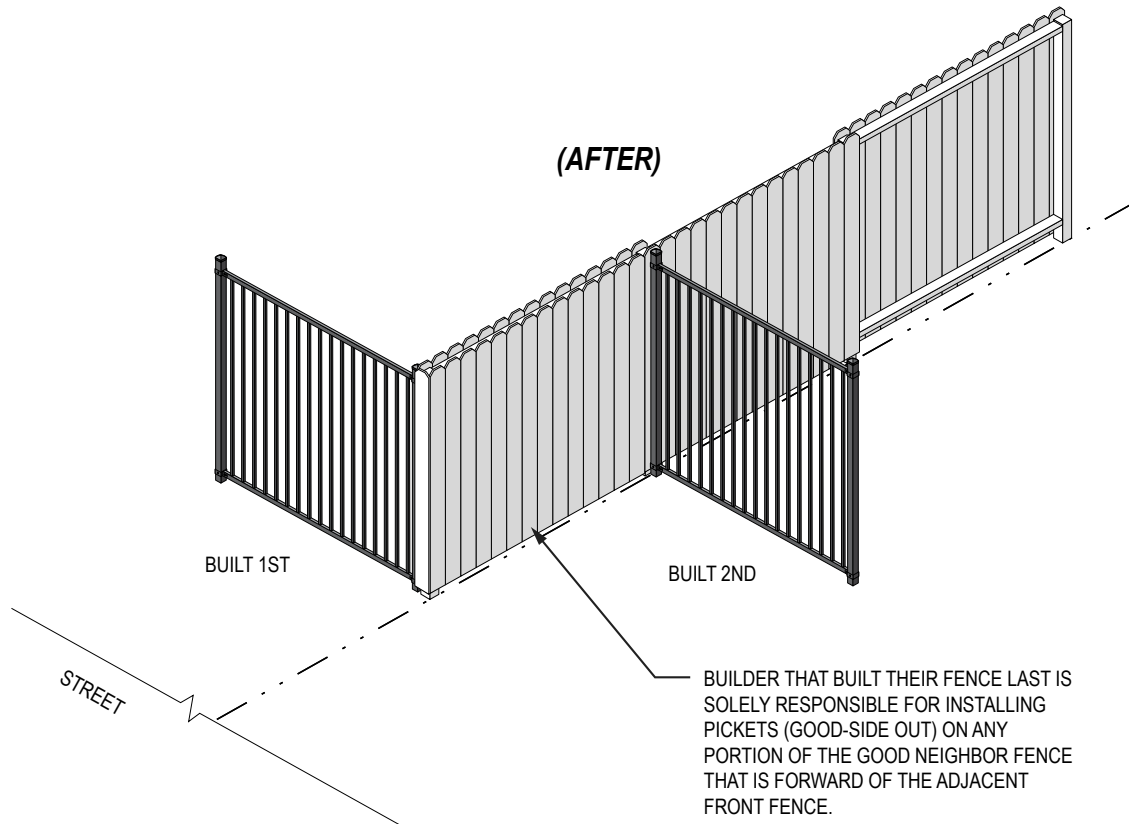
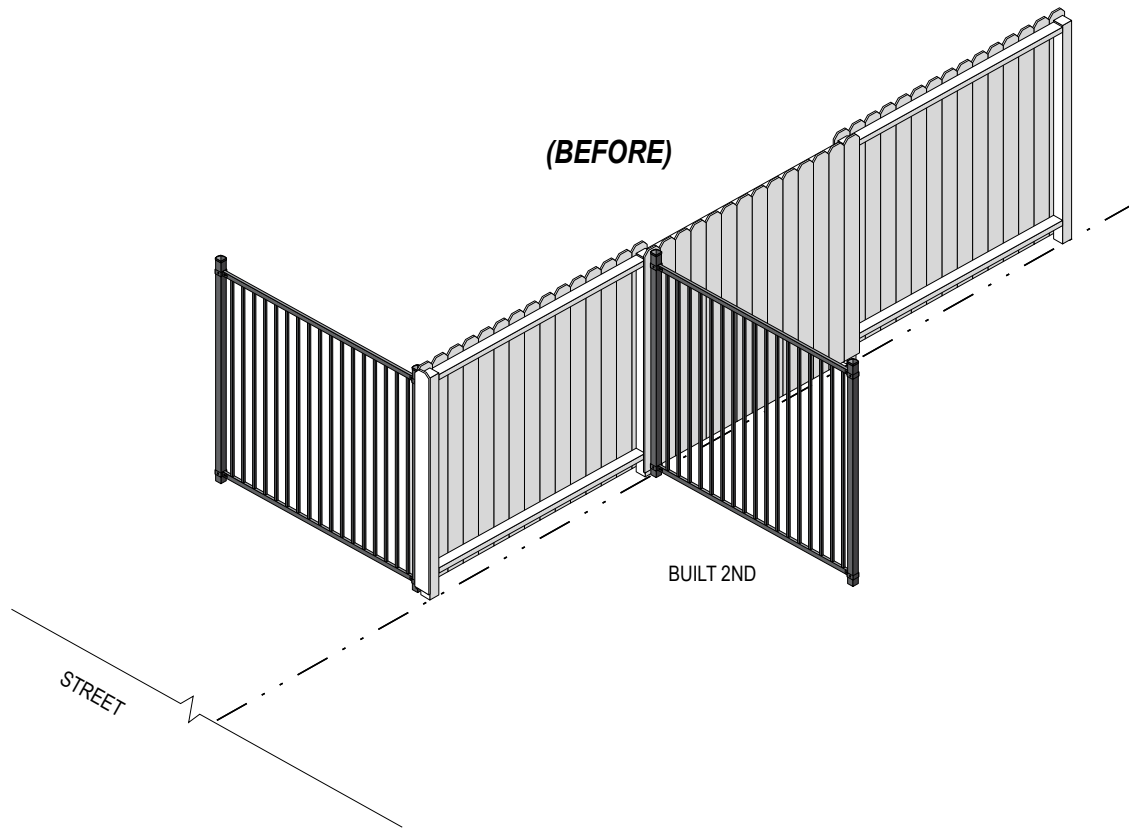

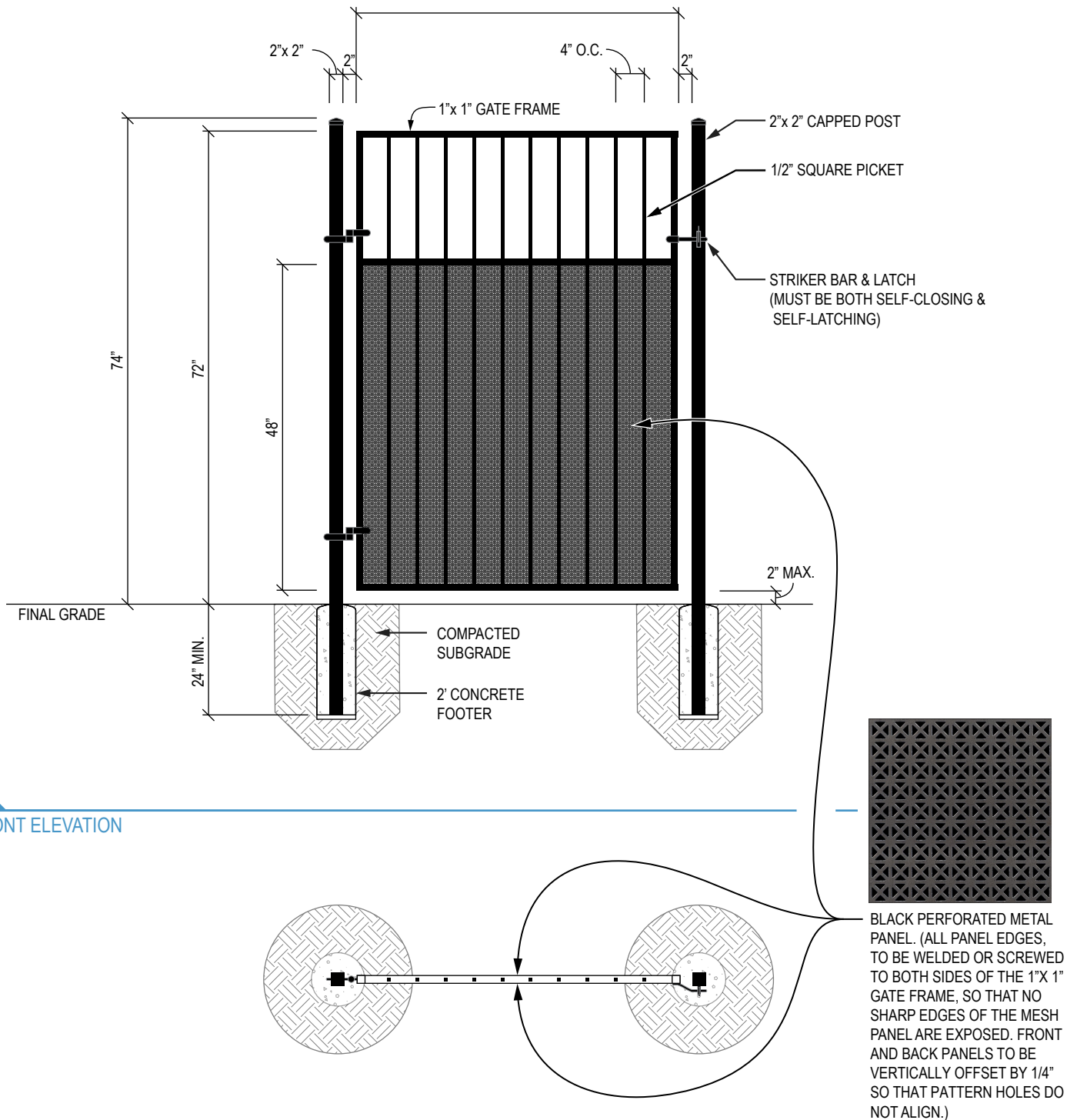

FRONT ELEVATION

PLAN VIEW - LOWER SECTION

NOTES:

1. GATE MUST BE BOTH SELF-CLOSING AND SELF-LATCHING.
2. BLACK PERFORATED METAL PANEL IS:
  - REQUIRED - ON ALL GATES BETWEEN HOMES (INCLUDING CORNER LOTS AND LOTS THAT SIDE A STREET OR AMENITY / LANDSCAPE RESERVE).
  - OPTIONAL - ON GATES OF CORNER LOTS AND AMENITY LOTS (IF GATE IS INSTALLED ON THE FRONT FENCE, CLOSEST TO A SIDE STREET OR AMENITY / LANDSCAPE RESERVE).
3. ALL METAL TO BE BLACK POWDER-COATED 11 GAUGE STEEL (EXCLUDING THE BLACK PERFORATED METAL PANEL WHICH SHALL BE AS MCNICHOLS PERFORATED METAL, DESIGNER PERFORATED, GRECIAN 2235, CARBON STEEL OR DEVELOPER-APPROVED EQUAL).
4. NO UNFINISHED / UNPAINTED METAL IS PERMITTED.
5. BUILDER IS SOLELY RESPONSIBLE & LIABLE FOR ENSURING THAT ALL FENCES, GATES, AND SAFETY BARRIERS MEET OR EXCEED APPLICABLE CODE(S).

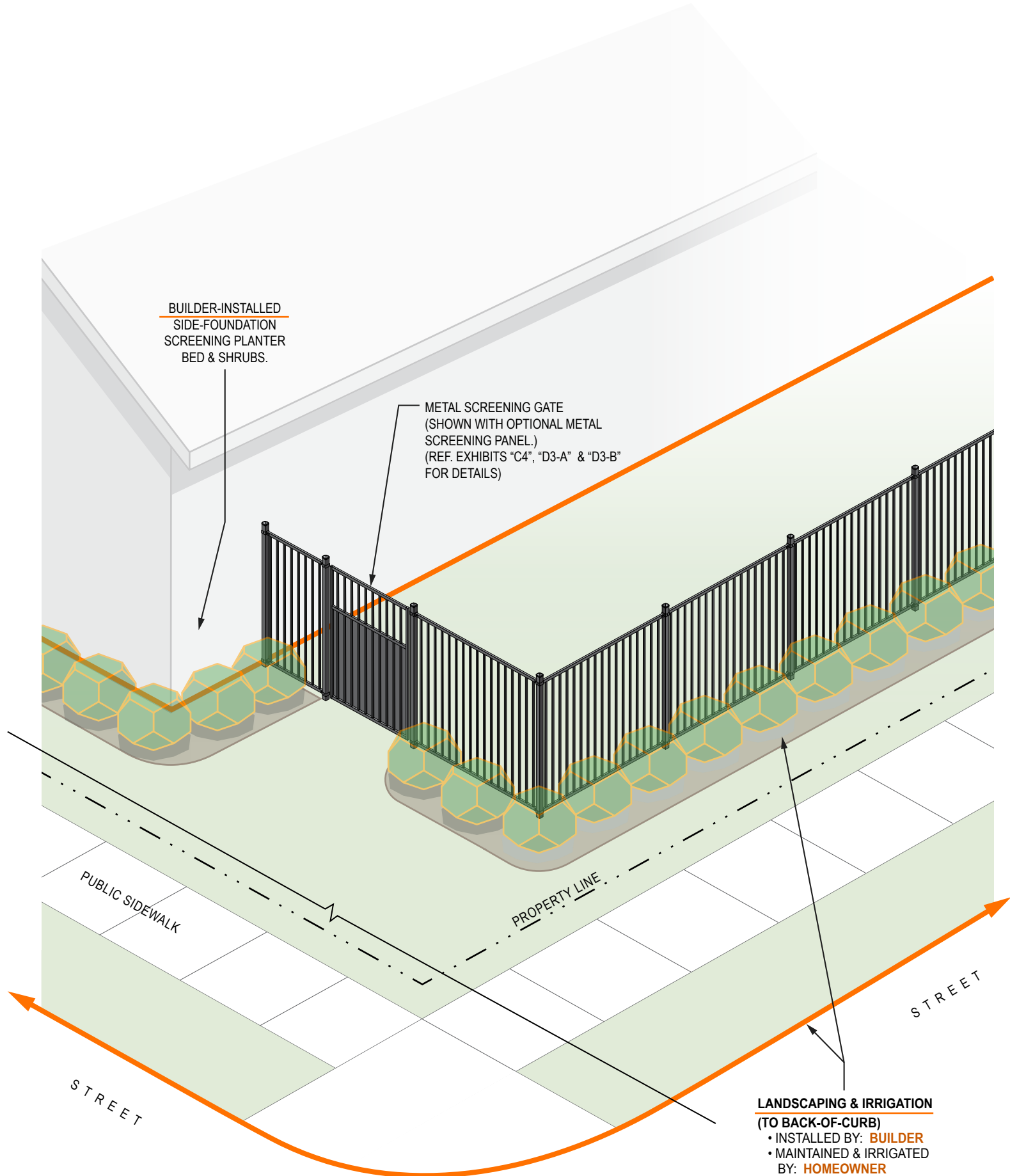

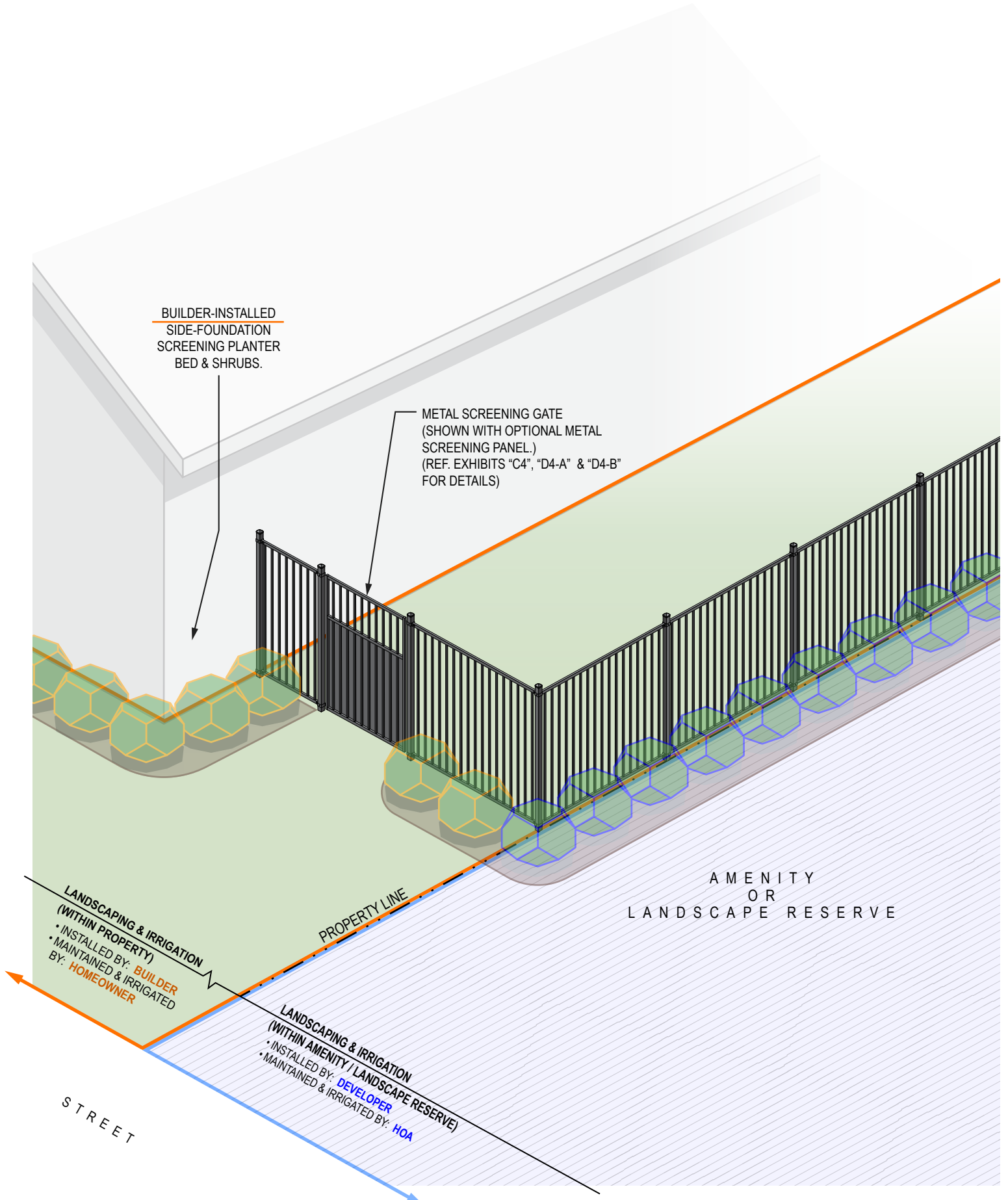

SCALE: NTS

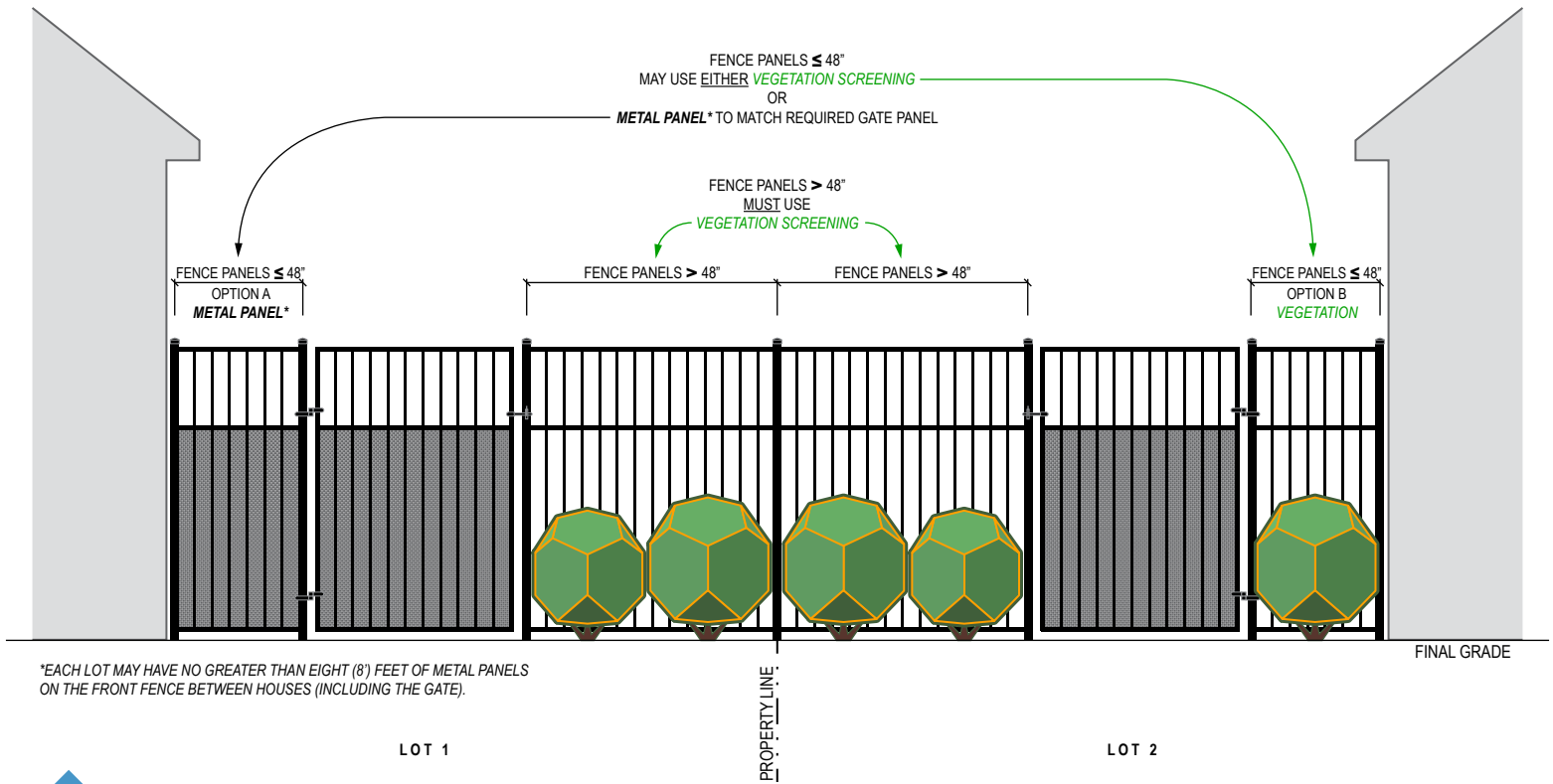

EXAMPLE A - LARGER LOTS (TYPICAL)

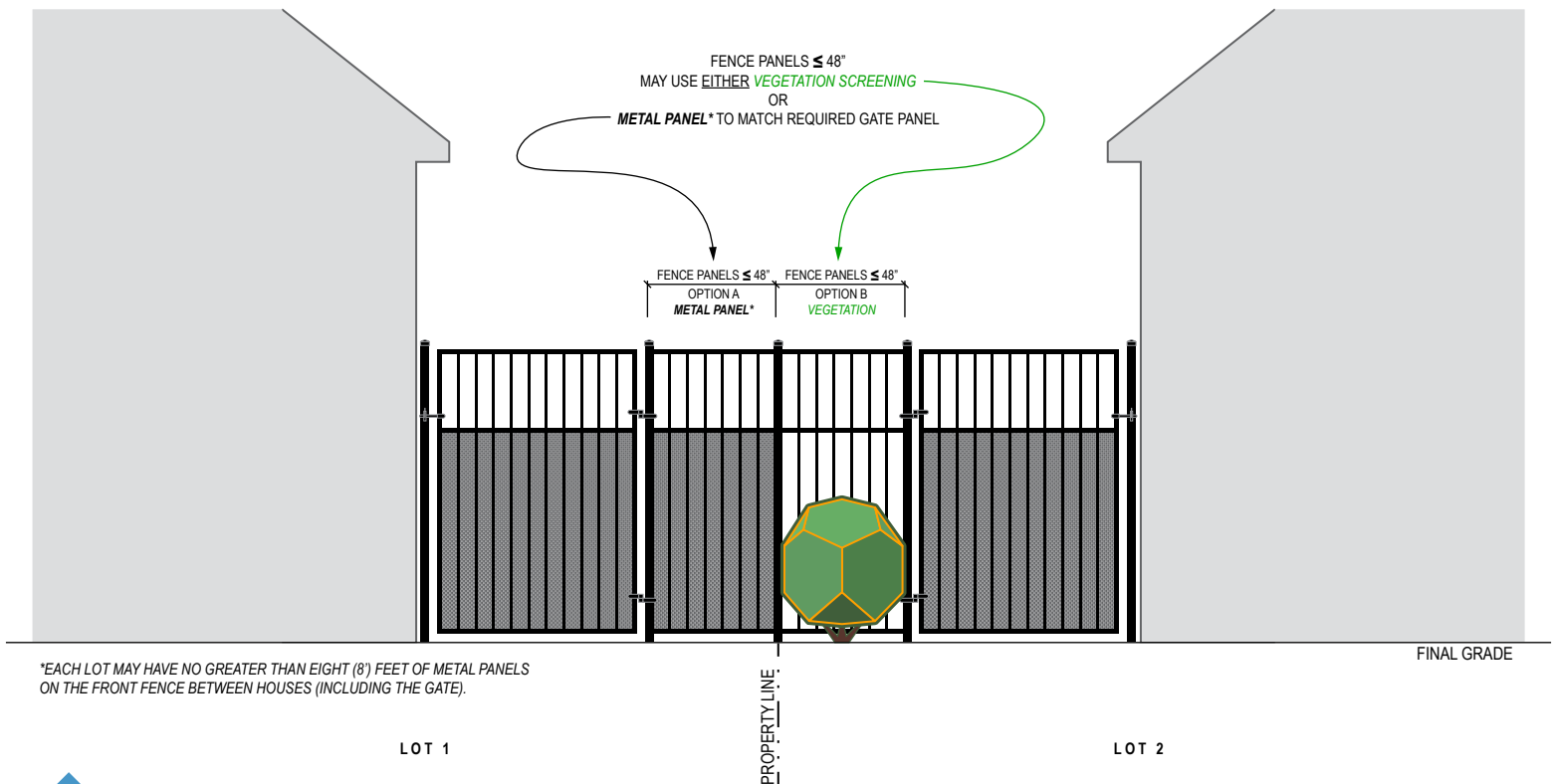

EXAMPLE B - SMALLER LOTS (TYPICAL)

- NOTES:
1. ALL SCREENING VEGETATION SHALL BE EVERGREEN, HARDY, AND INSTALLED BY BUILDER AND IRRIGATED & MAINTAINED BY HOMEOWNER. (REF/ EXHIBIT "D9").
  2. SCREENING VEGETATION/SHRUB SHALL BE A MINIMUM OF 3-GALLONS OR 1/4 THE HEIGHT OF THE FENCE WHEN PLANTED, WHICHEVER IS GREATER.

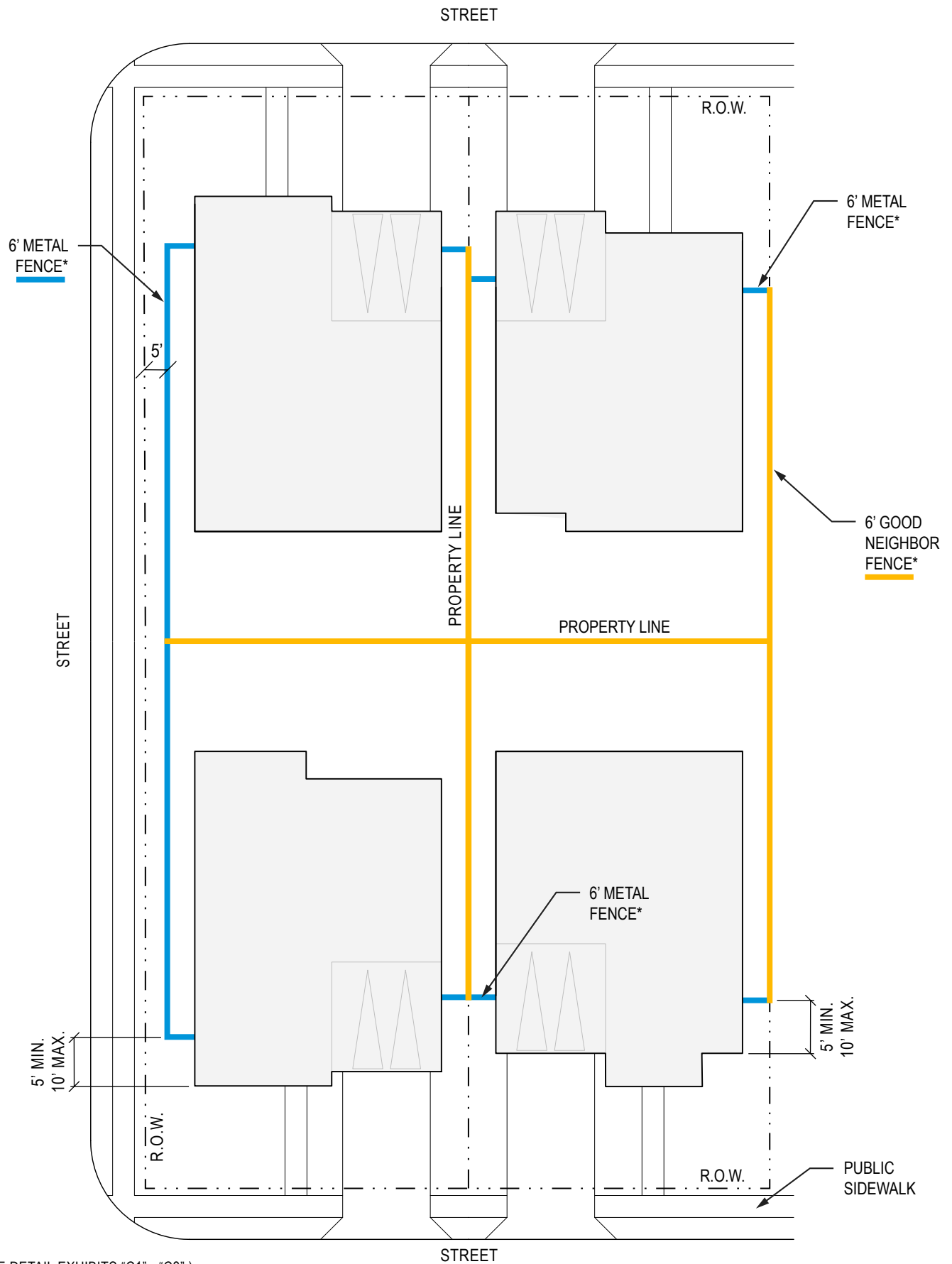

(\*SEE FENCE DETAIL EXHIBITS "C1" - "C3".)

(SOME FENCE TYPES ON PARTICULAR LOTS MAY VARY. PLEASE SEE "SECTION FENCE & DRIVEWAY LAYOUTS" TO ENSURE CORRECT FENCE TYPE AND LOCATION.)

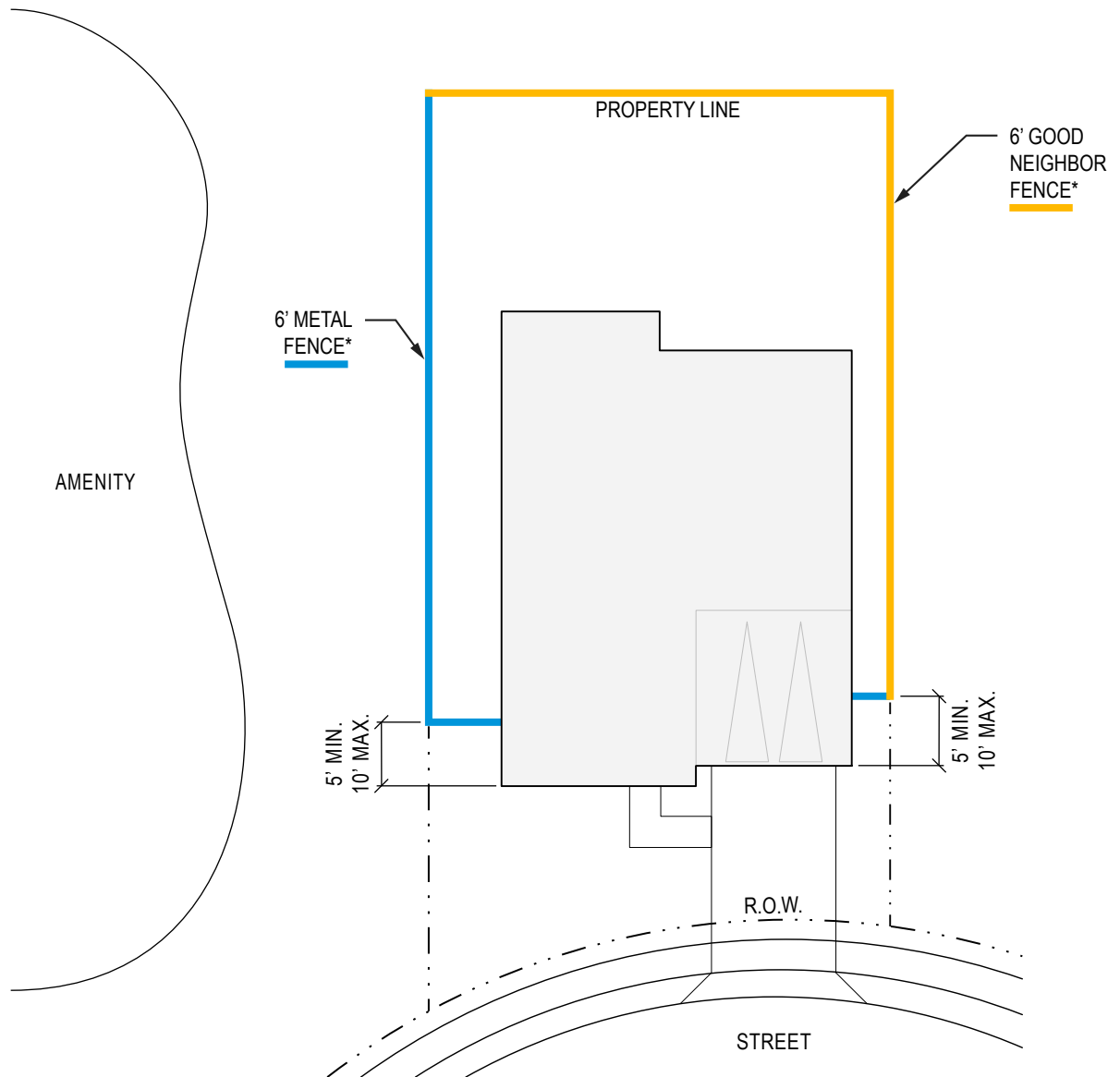

(\*SEE FENCE DETAIL EXHIBITS "C1" - "C3".)

(SOME FENCE TYPES ON PARTICULAR LOTS MAY VARY. PLEASE SEE "SECTION FENCE & DRIVEWAY LAYOUTS" TO ENSURE CORRECT FENCE TYPE AND LOCATION.)



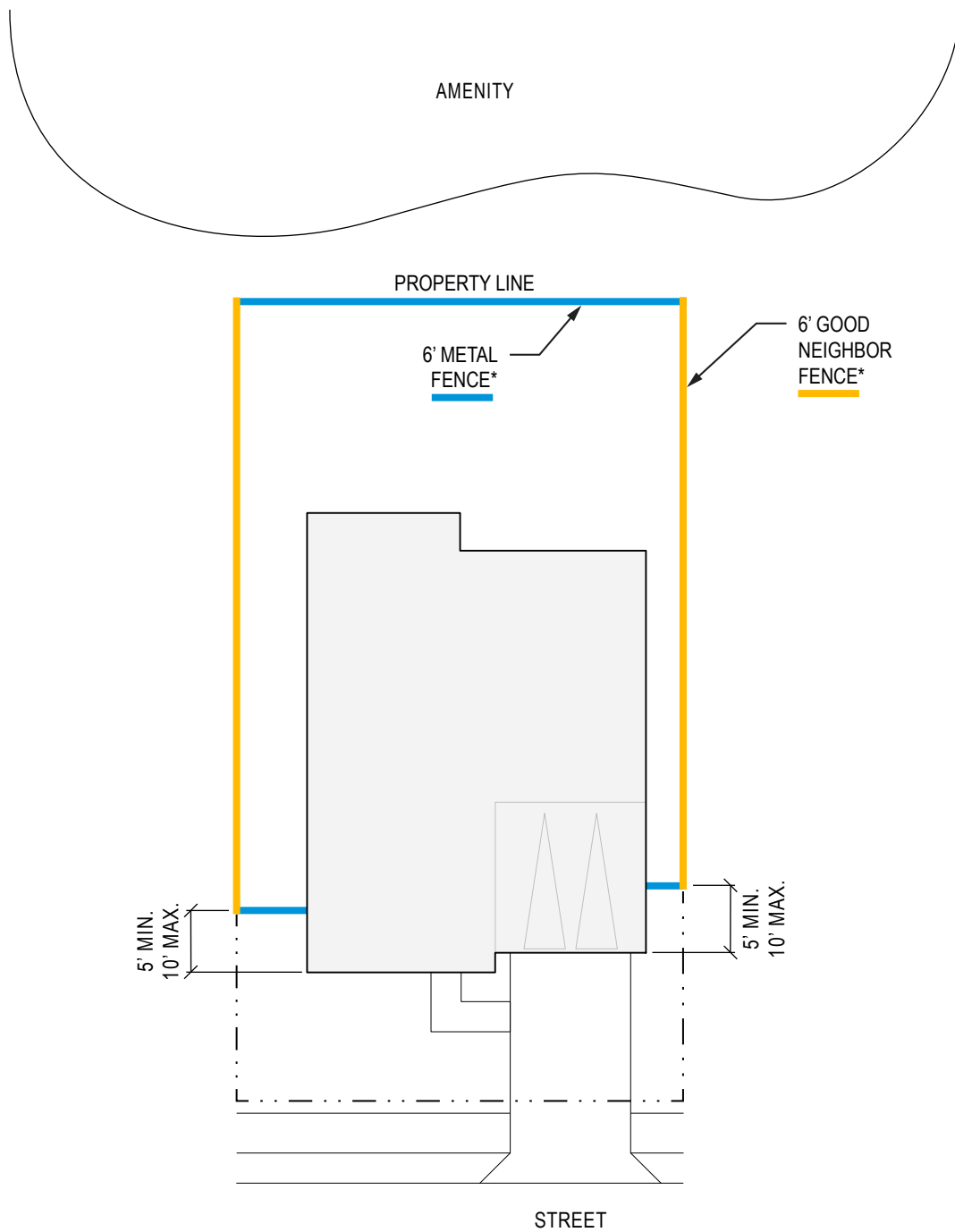

(\*SEE FENCE DETAIL EXHIBITS "C1" - "C3".)

(SOME FENCE TYPES ON PARTICULAR LOTS MAY VARY. PLEASE SEE "SECTION FENCE & DRIVEWAY LAYOUTS" TO ENSURE CORRECT FENCE TYPE AND LOCATION.)

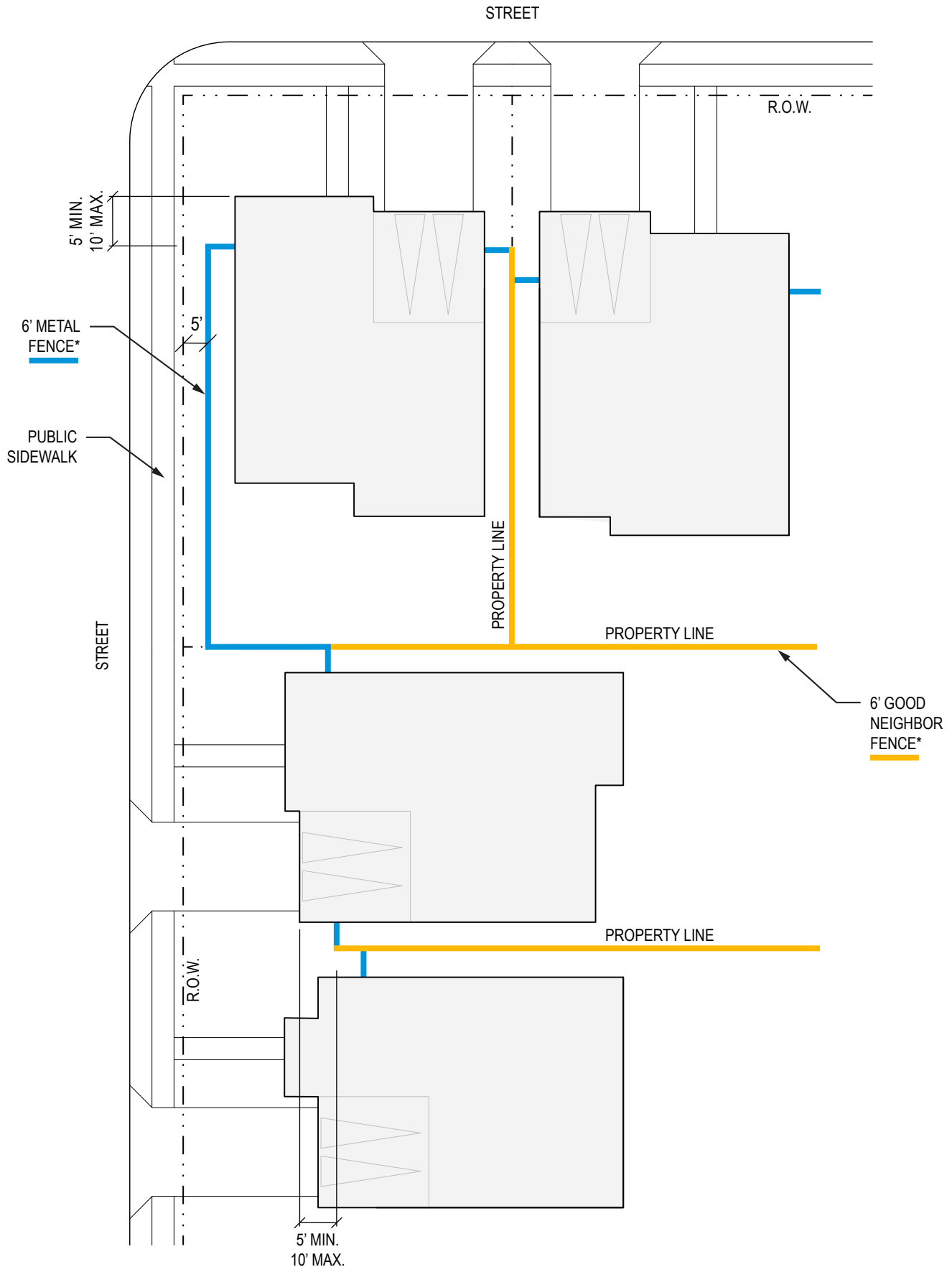

(\*SEE FENCE DETAIL EXHIBITS "C1" - "C3".)

(SOME FENCE TYPES ON PARTICULAR LOTS MAY VARY. PLEASE SEE "SECTION FENCE & DRIVEWAY LAYOUTS" TO ENSURE CORRECT FENCE TYPE AND LOCATION.)

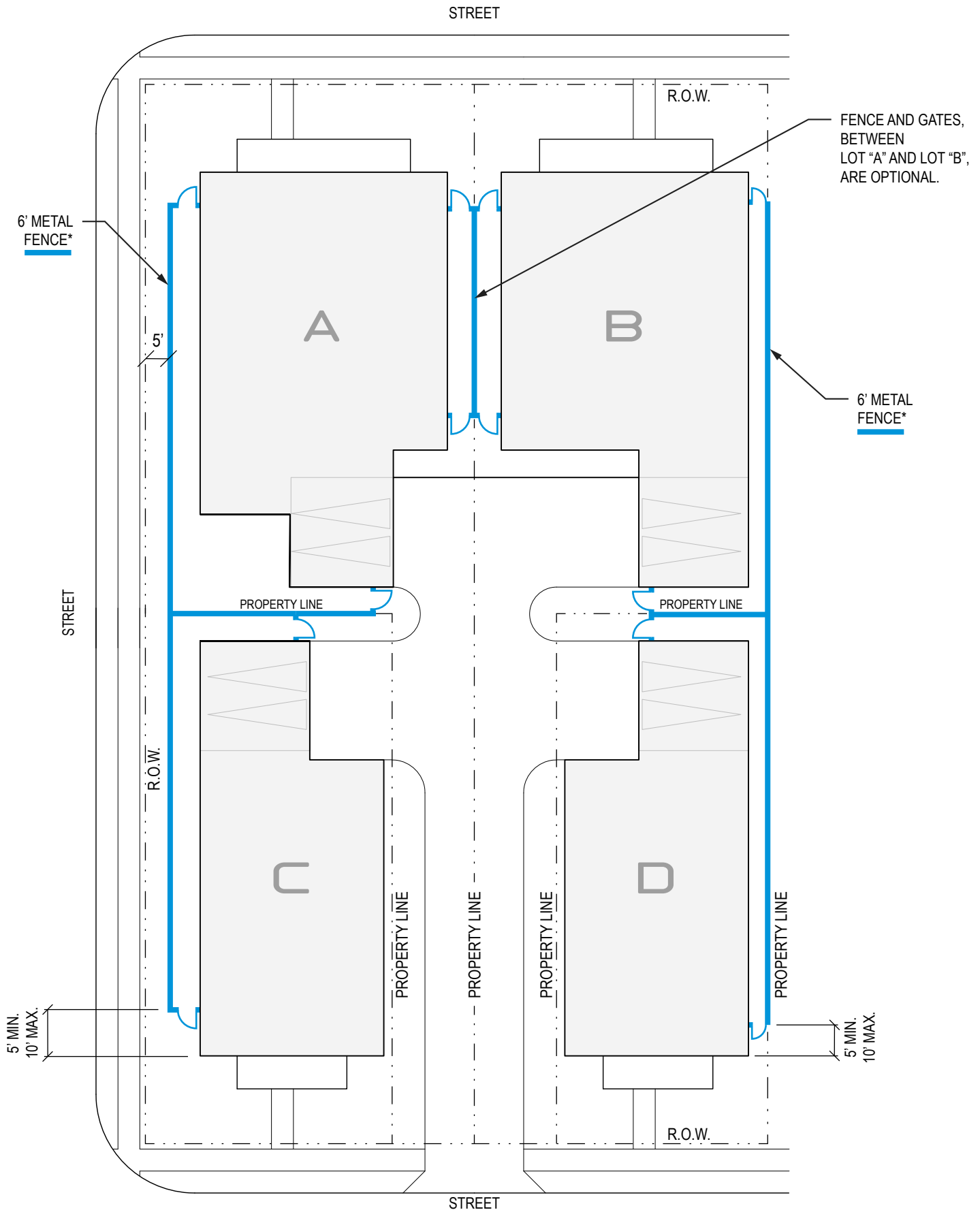

(\*SEE FENCE DETAIL EXHIBIT "C2".)

(SOME FENCE TYPES ON PARTICULAR LOTS MAY VARY. PLEASE SEE "SECTION FENCE & DRIVEWAY LAYOUTS" TO ENSURE CORRECT FENCE TYPE AND LOCATION.)

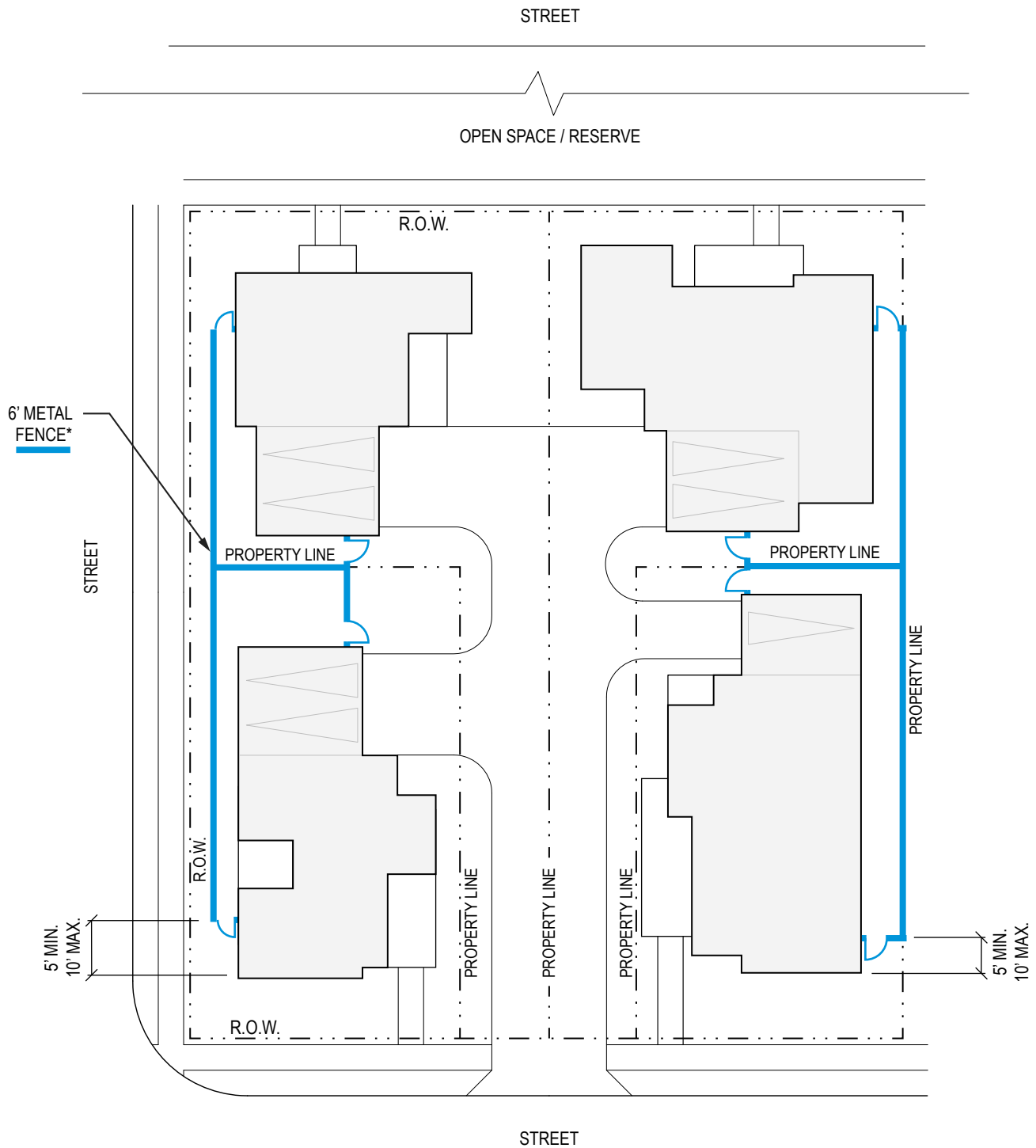

(\*SEE FENCE DETAIL EXHIBIT "C2".)

(SOME FENCE TYPES ON PARTICULAR LOTS MAY VARY. PLEASE SEE "SECTION FENCE & DRIVEWAY LAYOUTS" TO ENSURE CORRECT FENCE TYPE AND LOCATION.)

Section Fence & Driveway Layouts are available at [www.KenAnderson.com](http://www.KenAnderson.com) > Residential > Easton Park



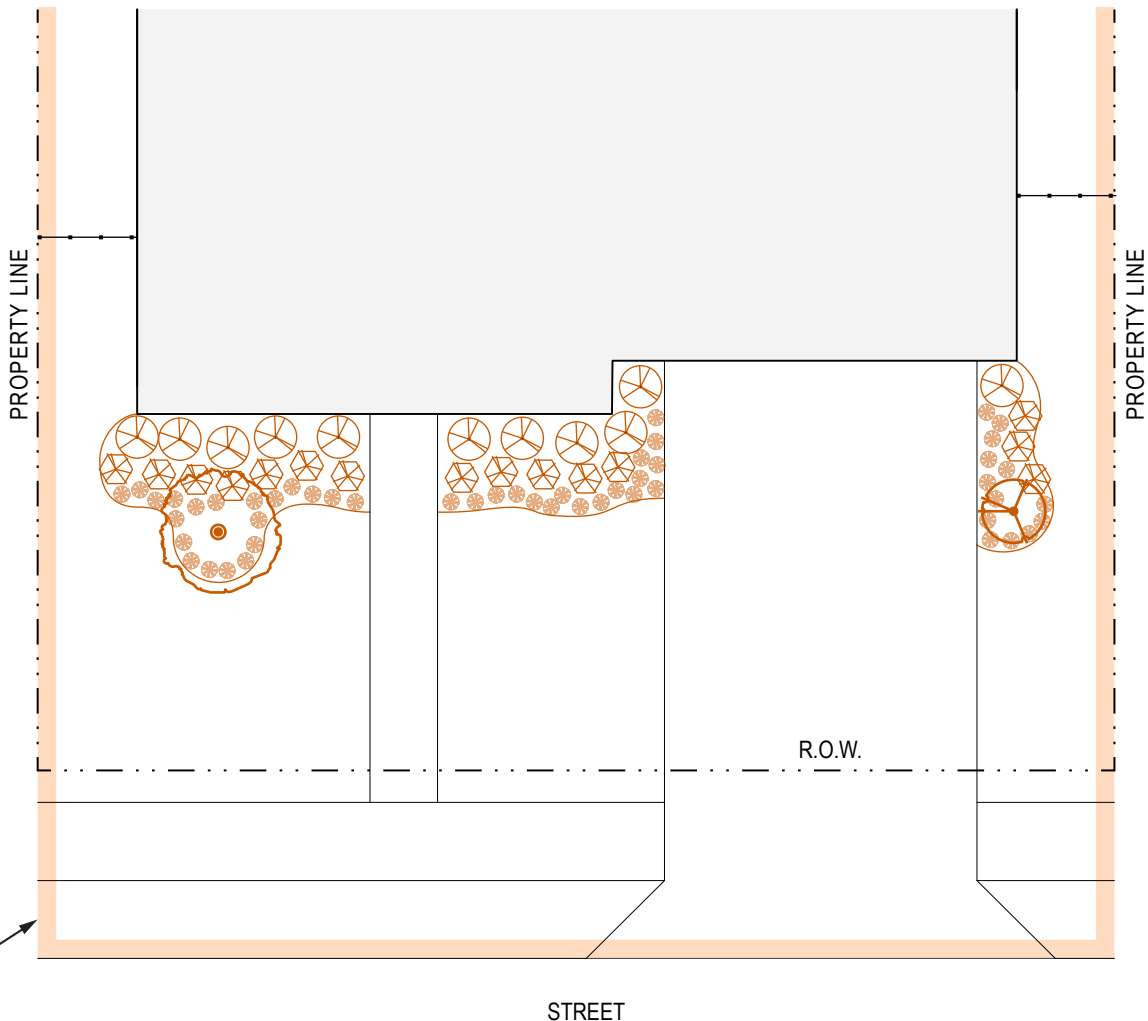

**LANDSCAPING & IRRIGATION  
(TO BACK-OF-CURB)**

- INSTALLED BY: **BUILDER**
- MAINTAINED & IRRIGATED BY: **HOMEOWNER**

NOTES

1. REFERENCE LANDSCAPE REQUIREMENTS AND APPROVED PLANTING LIST.
2. ALL YARDS SHALL BE FULLY IRRIGATED.
3. SOD SHALL BE BERMUDA.
4. PLANTER BEDS REQUIRE TWO (2") INCHES OF MULCH.
5. TREE CALIPER TO BE MEASURED AT TWO (2') FEET ABOVE NATURAL GRADE.
6. PLANTING SHALL NOT IMPEDE DRAINAGE.

FRONT YARD - MINIMUM PLANT QUANTITY REQUIREMENTS				
LOT WIDTH(S)	TREES		HARDY SHRUBS	
	3" CALIPER SHADE TREE	1.5" CALIPER ORNAMENTAL TREE*	1 GALLON	5 GALLON
50'	1	1	15	10
60'	1	1	18	12

\* (MINIMUM OF SIX (6') FEET TALL AT INSTALLATION.)



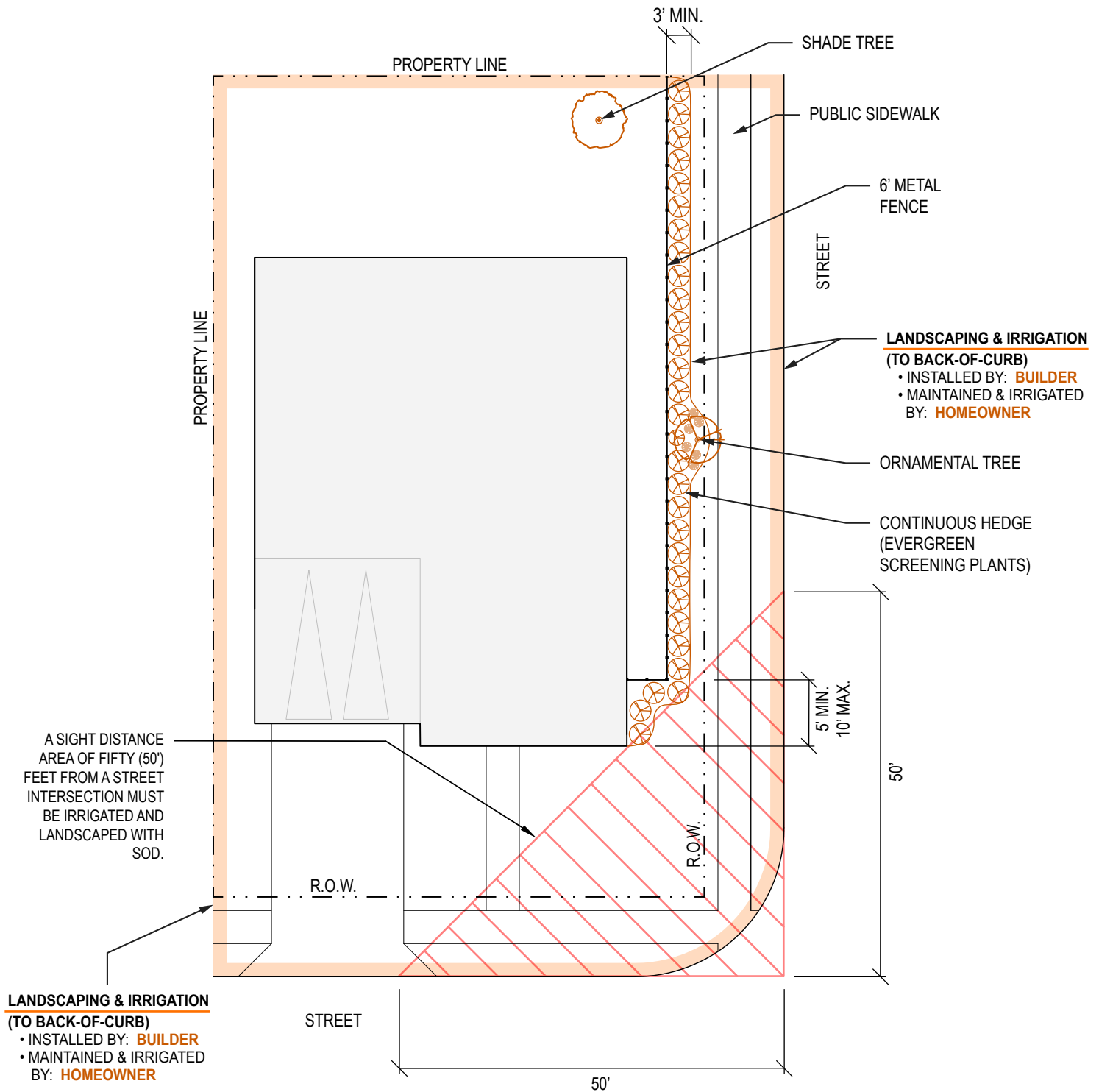

**NOTES**

1. REFERENCE LANDSCAPE REQUIREMENTS AND APPROVED PLANTING LIST.
2. ALL YARDS SHALL BE FULLY IRRIGATED.
3. SOD SHALL BE BERMUDA.
4. PLANTER BEDS REQUIRE TWO (2") INCHES OF MULCH.
5. TREE CALIPER TO BE MEASURED AT TWO (2') FEET ABOVE NATURAL GRADE.
6. PLANTING SHALL NOT IMPEDE DRAINAGE.

CORNER SIDE YARD - MINIMUM PLANT QUANTITY REQUIREMENTS			
LOT WIDTH(S)	TREES		HARDY SHRUBS
	1.5" CALIPER SHADE TREE	1.5" CALIPER ORNAMENTAL TREE*	24" MIN. HEIGHT AT INSTALLATION
50'	1	1	CONTINUOUS HEDGE / EVERGREEN SCREENING PLANTS)
60'	1	1	

\*(MINIMUM OF SIX (6') FEET TALL AT INSTALLATION.)

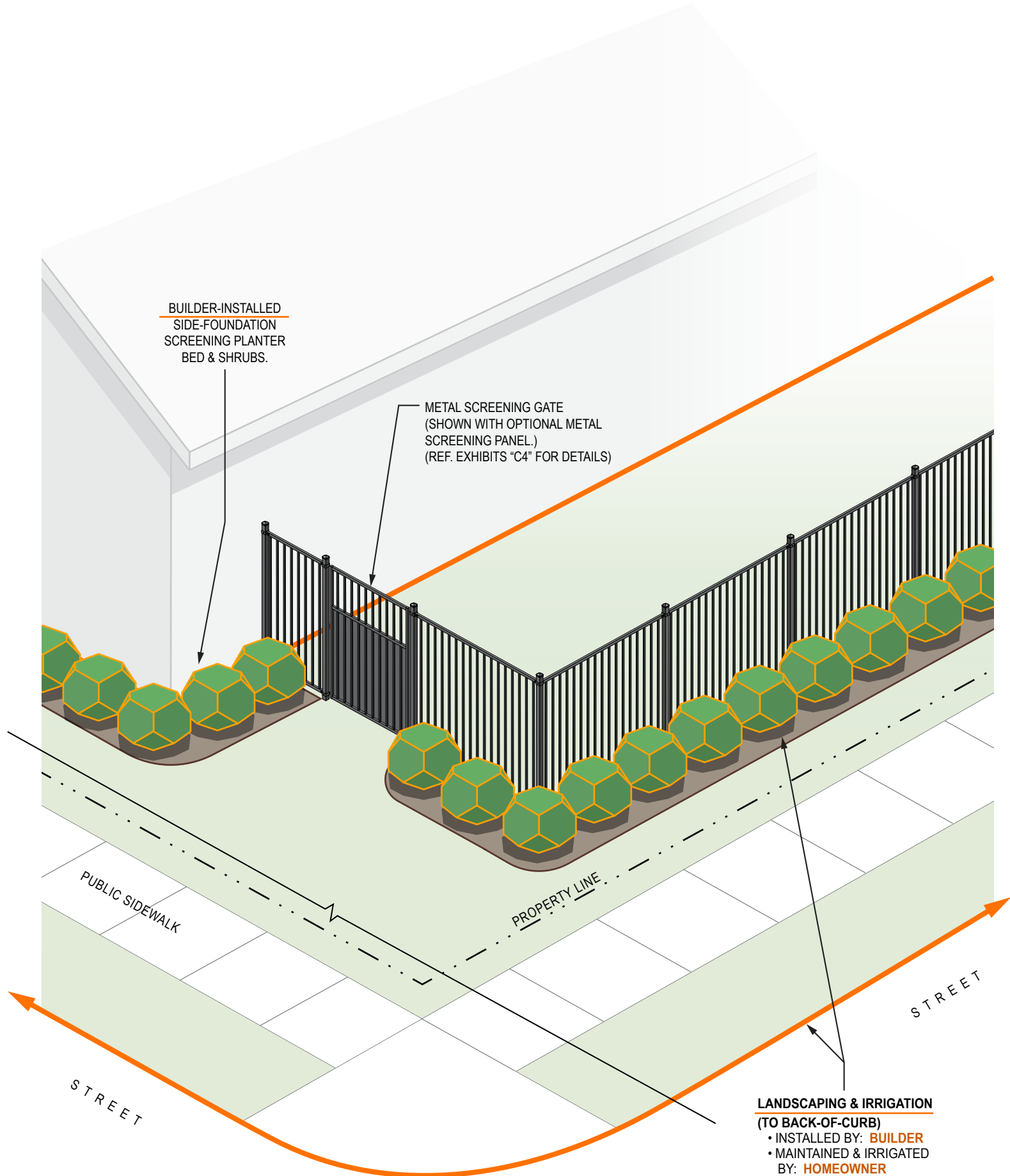

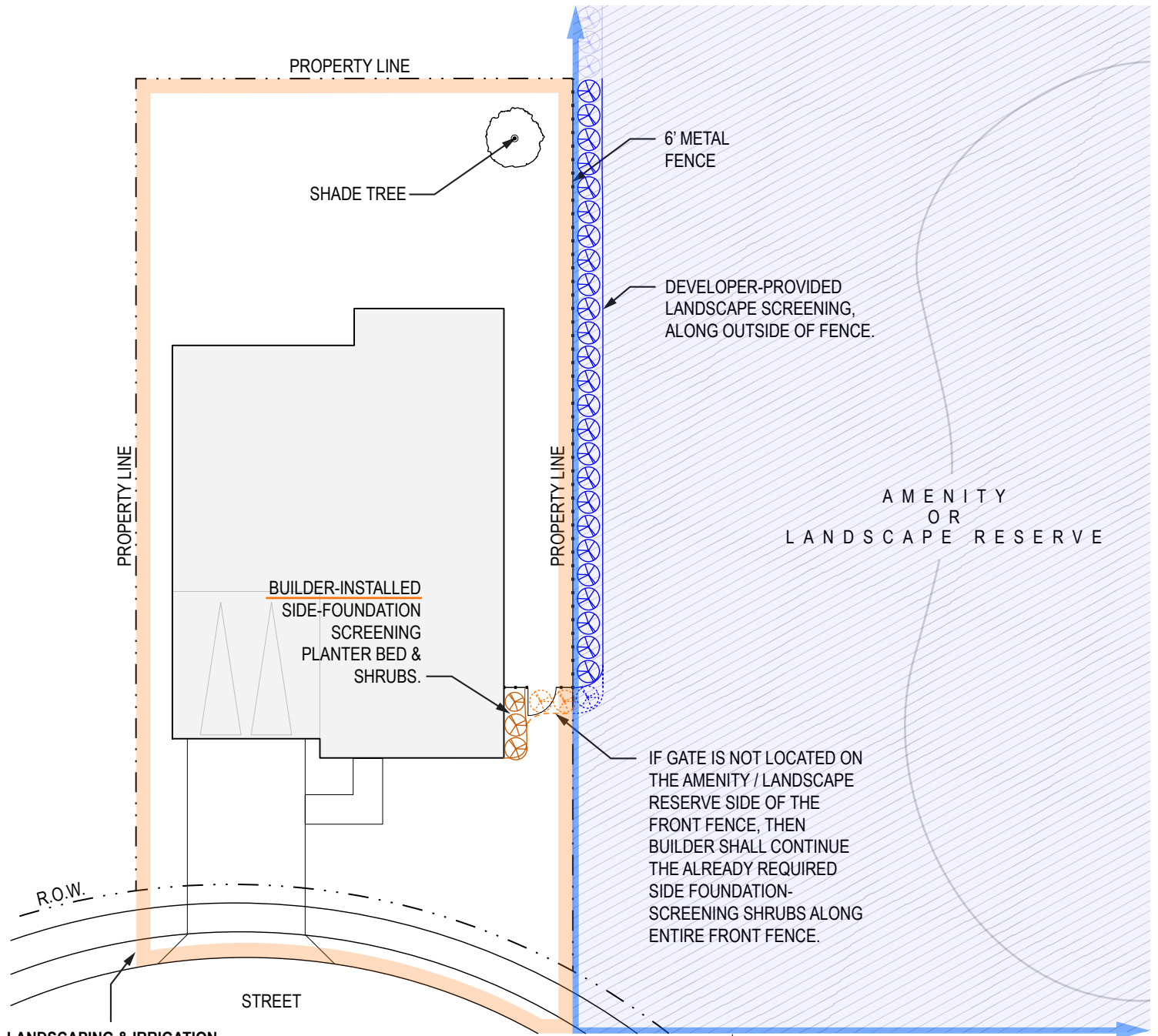

**LANDSCAPING & IRRIGATION**

**(TO BACK-OF-CURB)**

- INSTALLED BY: **BUILDER**
- MAINTAINED & IRRIGATED BY: **HOMEOWNER**

**LANDSCAPING & IRRIGATION**

**(WITHIN AMENITY / LANDSCAPE RESERVE)**

- INSTALLED BY: **DEVELOPER**
- MAINTAINED & IRRIGATED BY: **HOA**

**NOTES**

1. REFERENCE LANDSCAPE REQUIREMENTS AND APPROVED PLANTING LIST.
2. ALL YARDS SHALL BE FULLY IRRIGATED.
3. SOD SHALL BE BERMUDA.
4. PLANTER BEDS REQUIRE TWO (2") INCHES OF MULCH.
5. TREE CALIPER TO BE MEASURED AT TWO (2') FEET ABOVE NATURAL GRADE.
6. PLANTING SHALL NOT IMPEDE DRAINAGE.

**AMENITY SIDE YARD - MINIMUM PLANT QUANTITY REQUIREMENTS**

LOT WIDTH(S)	TREES	HARDY SHRUBS
	1.5" CALIPER SHADE TREE	24" MIN. HEIGHT AT INSTALLATION
50'	1	CONTINUOUS HEDGE / EVERGREEN SCREENING PLANTS)
60'	1	

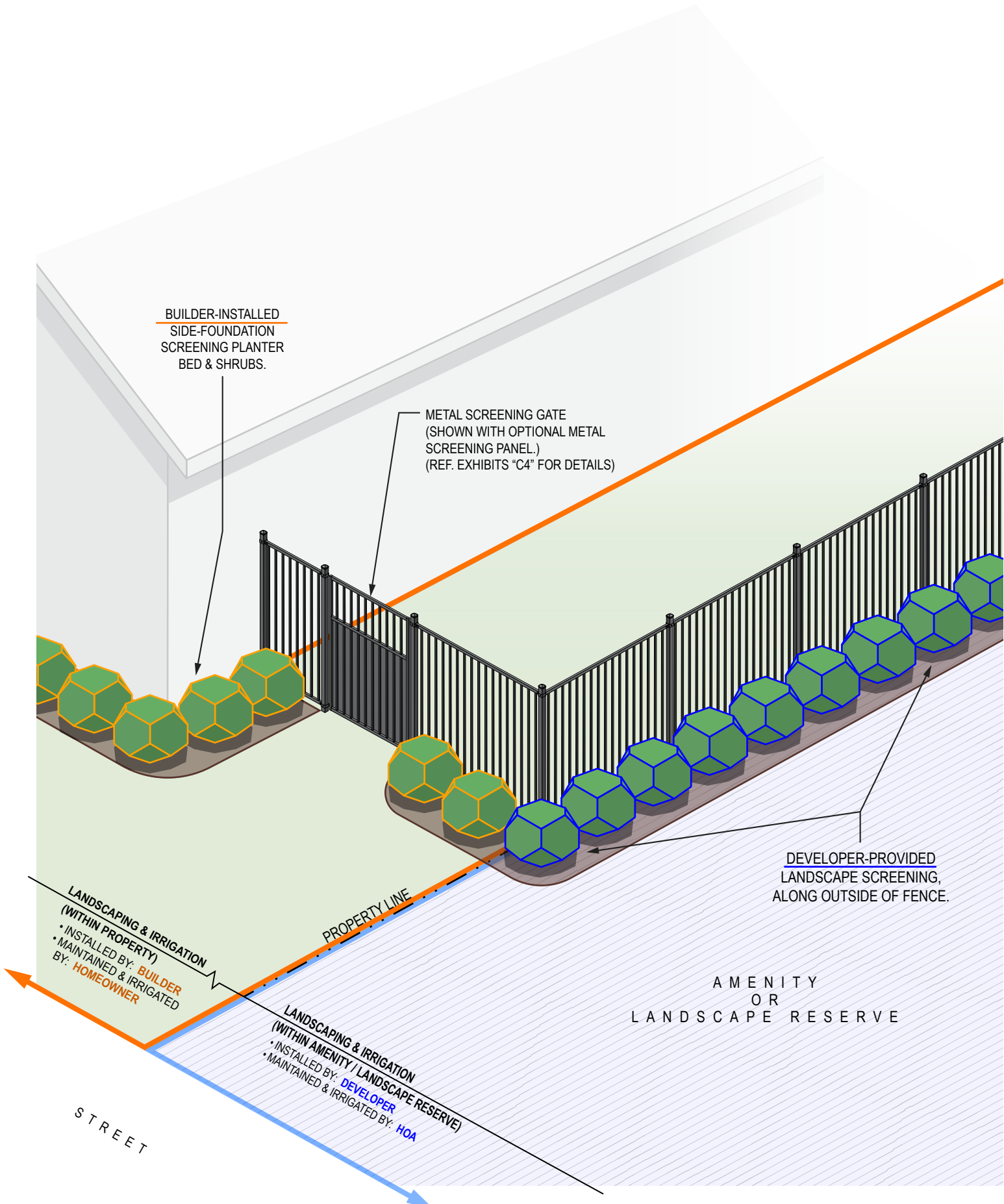

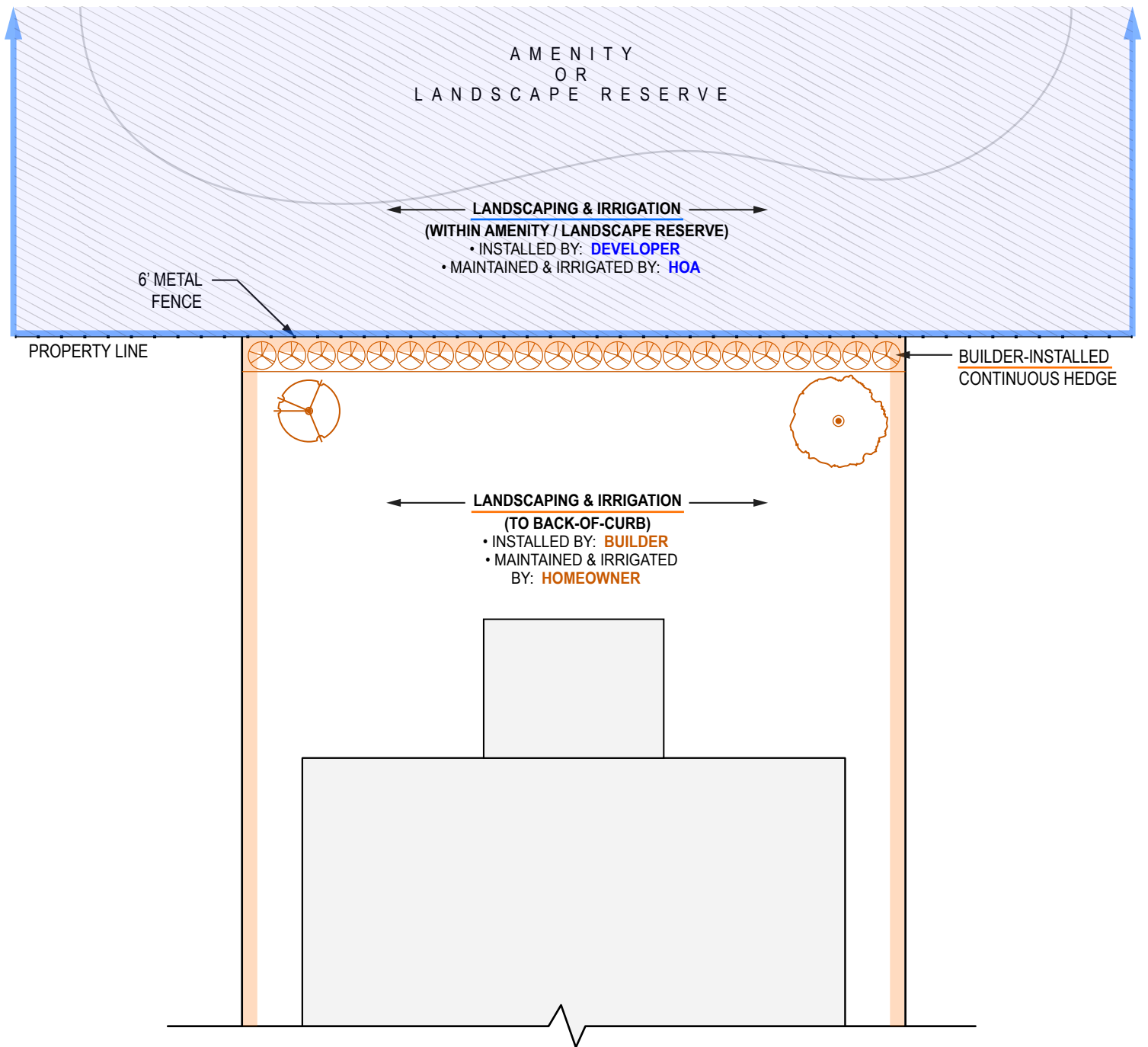

**NOTES**

1. REFERENCE LANDSCAPE REQUIREMENTS AND APPROVED PLANTING LIST.
2. ALL YARDS SHALL BE FULLY IRRIGATED.
3. SOD SHALL BE BERMUDA.
4. PLANTER BEDS REQUIRE TWO (2") INCHES OF MULCH.
5. TREE CALIPER TO BE MEASURED AT TWO (2') FEET ABOVE NATURAL GRADE.
6. PLANTING SHALL NOT IMPEDE DRAINAGE.

AMENITY REAR YARD - MINIMUM PLANT QUANTITY REQUIREMENTS			
LOT WIDTH(S)	TREES		HARDY SHRUBS
	1.5" CALIPER SHADE TREE	1.5" CALIPER ORNAMENTAL TREE*	24" MIN. HEIGHT AT INSTALLATION
50'	1	1	CONTINUOUS HEDGE / EVERGREEN SCREENING PLANTS)
60'	1	1	

\* (MINIMUM OF SIX (6') FEET TALL AT INSTALLATION.)

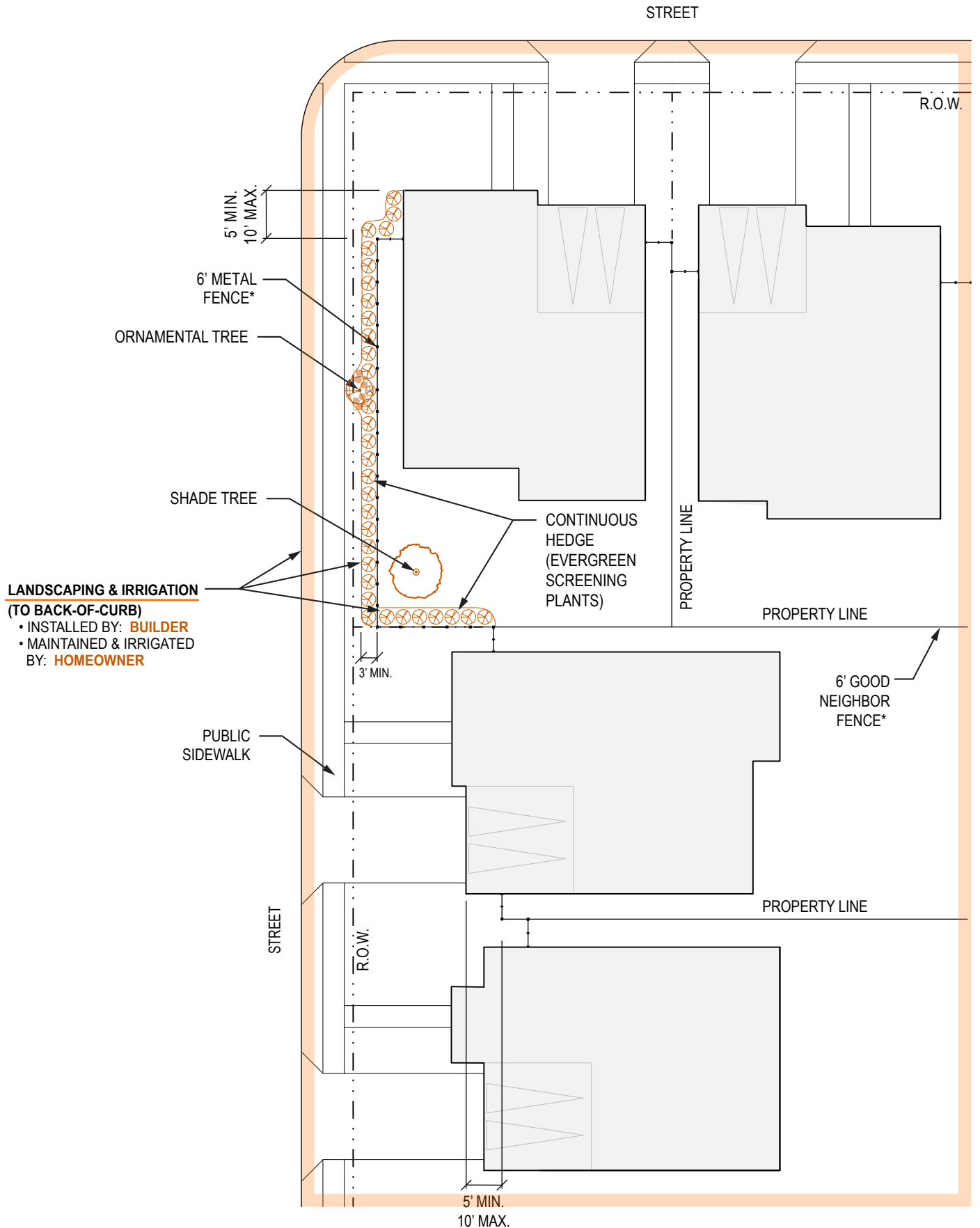

(\*SEE FENCE DETAIL EXHIBITS "C1" - "C4".)  
(SOME FENCE TYPES ON PARTICULAR LOTS MAY VARY. PLEASE SEE "SECTION FENCE & DRIVEWAY LAYOUTS" TO ENSURE CORRECT FENCE TYPE AND LOCATION.)



MOTOR COURT MINIMUM PLANT QUANTITY REQUIREMENTS (PER LOT)				
YARD DESIGNATION	TREES		HARDY SHRUBS	
	SHADE TREE (3" CALIPER)	ORNAMENTAL TREE* (1.5" CALIPER)	1 GAL.	5 GAL.
FRONT YARD	1	1	15	10
REAR YARD	0	0	0	0
COURTYARD	0	0	**	**
INTERIOR SIDE YARD	0	0	0	0
CORNER SIDE YARD	0	1	***	***
PARKWAY STRIP	N/A	N/A	N/A	N/A

\*(MINIMUM OF SIX (6') FEET TALL AT INSTALLATION.)

\*\* (SUFFICIENT QUANTITY TO ADEQUATELY MINIMIZE VISIBILITY OF FOUNDATION.)

\*\*\* (SUFFICIENT QUANTITY TO ADEQUATELY SCREEN ALONG SIDE FENCE.)

MINI MOTOR COURT MINIMUM PLANT QUANTITY REQUIREMENTS (PER LOT)				
YARD DESIGNATION	TREES		HARDY SHRUBS	
	SHADE TREE (3" CALIPER)	ORNAMENTAL TREE* (1.5" CALIPER)	1 GAL.	5 GAL.
FRONT YARD	1	1	13	8
REAR YARD	0	0	0	0
COURTYARD	0	0	**	**
INTERIOR SIDE YARD	0	0	0	0
CORNER SIDE YARD	0	1	***	***
PARKWAY STRIP	N/A	N/A	N/A	N/A

\*(MINIMUM OF SIX (6') FEET TALL AT INSTALLATION.)

\*\* (SUFFICIENT QUANTITY TO ADEQUATELY MINIMIZE VISIBILITY OF FOUNDATION.)

\*\*\* (SUFFICIENT QUANTITY TO ADEQUATELY SCREEN ALONG SIDE FENCE.)

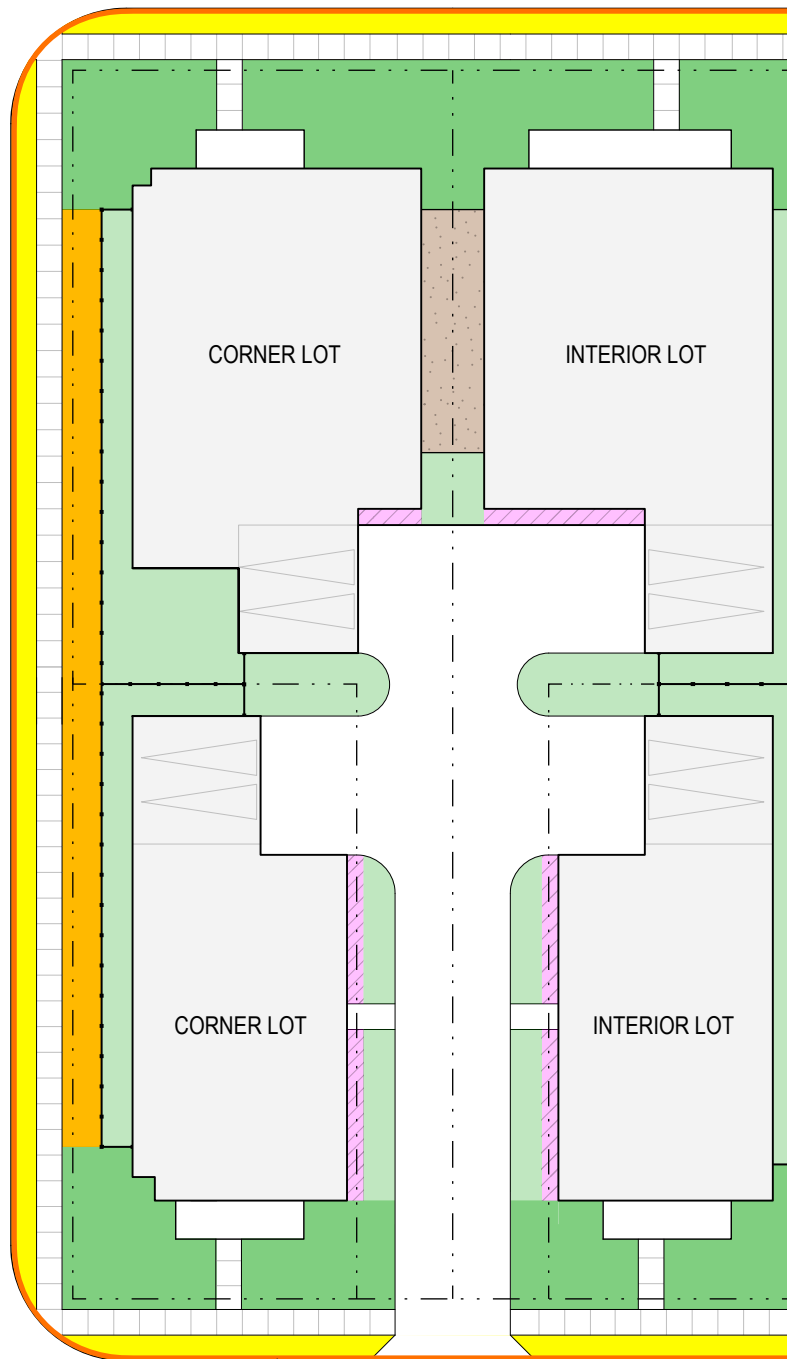

### LANDSCAPING & IRRIGATION

(WITHIN THIS LINE, INCLUDING TO BACK-OF-CURB)

**SHALL BE:**

- INSTALLED BY: **BUILDER**
- MAINTAINED & IRRIGATED BY: **HOMEOWNER**

### NOTES

1. REFERENCE LANDSCAPE REQUIREMENTS AND APPROVED PLANTING LIST.
2. ALL YARDS SHALL BE FULLY IRRIGATED.
3. SOD SHALL BE BERMUUDA.
4. PLANTER BEDS REQUIRE TWO (2") INCHES OF MULCH.
5. TREE CALIPER TO BE MEASURED AT TWO (2') FEET ABOVE NATURAL GRADE.
6. PLANTING SHALL NOT IMPEDE DRAINAGE.

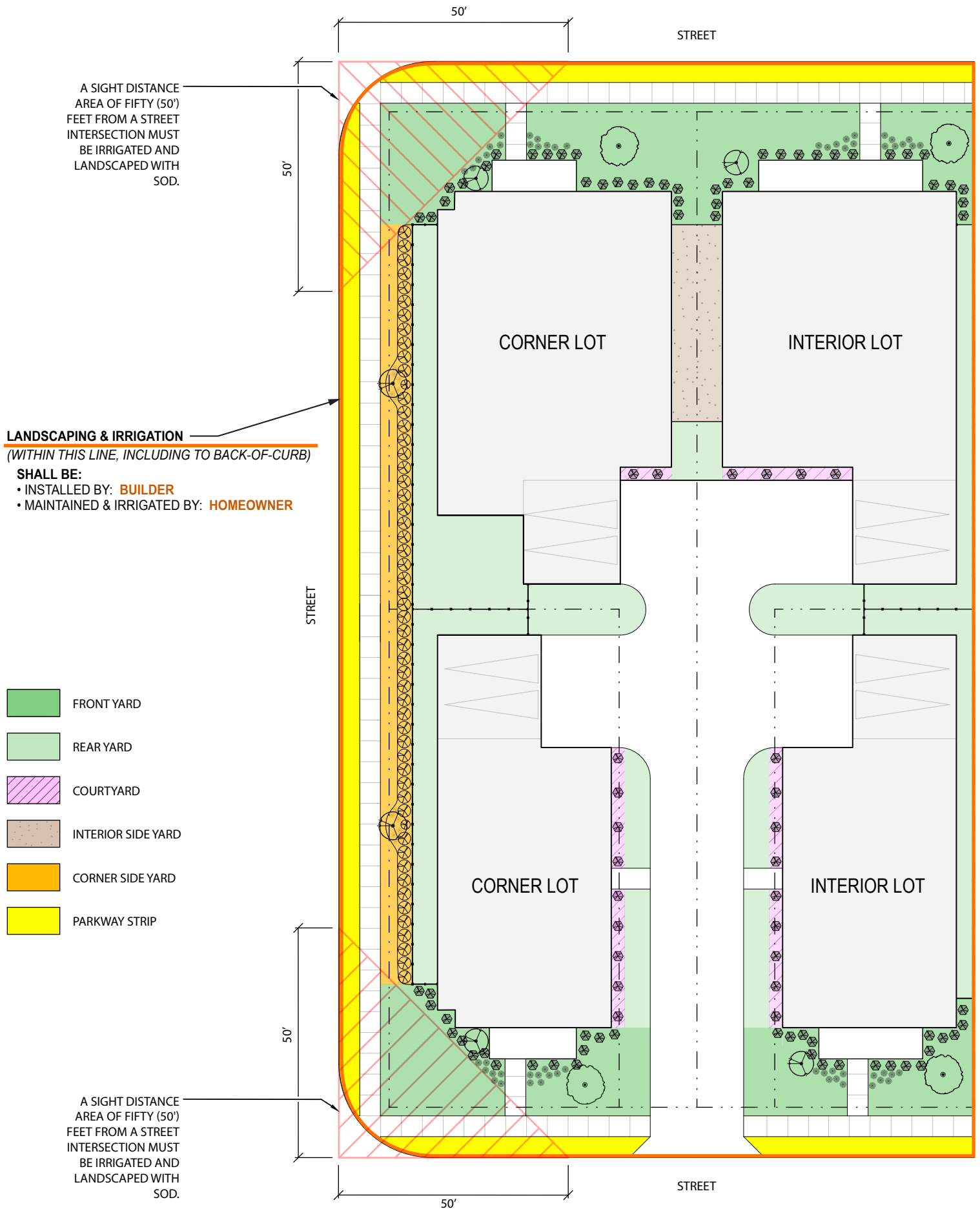



Please note that invasive species of plants are not permitted for use in Easton Park. For the most current list of prohibited invasive plants please reference the list at [www.GrowGreen.org](http://www.GrowGreen.org)

NATIVE SHADE TREES	
COMMON NAME	SCIENTIFIC NAME
Bald Cypress	Taxodium distichum
Bur Oak	Quercus macrocarpa
Cedar Elm	Ulmus crassifolia
Chinquapin Oak	Quercus muehlenbergii
Escarpment Live Oak*	Quercus fusiformis
Pecan	Carya illinoensis
Shumard Oak	Quercus shumardii
Southern Live Oak*	Quercus virginiana*

PERENNIALS	
COMMON NAME	SCIENTIFIC NAME
Coreopsis	Coreopsis lanceolata
Evening Primrose	Oenothera
Fall Aster	Symphotrichum oblongifolium
Gaura	Gaura lindheimeri
Gregg's Mistflower	Conoclinium greggii
Winecup	Callirhoe involucrata
Yarrow	Achillea millefolium
Yellow (Golden) Columbine	Aquilegia chrysantha

ORNAMENTAL TREES	
COMMON NAME	SCIENTIFIC NAME
Desert Willow	Chilopsis linearis
Flameleaf Sumac	Rhus copallinum
Mexican Plum	Prunus mexicana
Mexican Redbud	Cercis canadensis var. mexicana
Possumhaw Holly	Ilex decidua
Retama	Parkinsonia aculeata
Southern Wax Myrtle*	Myrica cerifera*
Texas Mountain Laurel	Dermatophyllum secundiflorum
Texas Persimmon	Diospyros texana
Texas Redbud	Cercis canadensis var. texensis
Yaupon Holly*	Ilex vomitoria*

GRASS - (ORNAMENTAL)	
COMMON NAME	SCIENTIFIC NAME
Basket Grass	Oplismenus hirtellus
Big Muhly	Muhlenbergia lindheimeri
Blue Grama	Bouteloua gracilis
Buffalo Grass	Bouteloua dactyloides
Deer Muhly/Deer Grass	Muhlenbergia rigens
Gulf Muhly	Muhlenbergia capillaris
Indian Grass	Sorghastrum nutans
Inland Sea Oats	Chasmanthium latifolium
Little Bluestem	Schizachyrium scoparium
Mexican Feather Grass	Nassella tenuissima
Side Oats Grama	Bouteloua curtipendula

LARGE SHRUBS	
COMMON NAME	SCIENTIFIC NAME
Dwarf Wax Myrtle	Myrica pusilla
Evergreen Sumac	Rhus virens
Southern Wax Myrtle* †	Myrica cerifera* †
Texas Sage* †	Leucophyllum frutescens* †
Barbados Cherry	Malpighia emarginata
Butterfly Bush	Buddleja
American Beautyberry	Callicarpa americana
Flameleaf Sumac	Rhus copallinum
Yellow Bells	Tecoma stans

GRASS - (LAWN)	
COMMON NAME	SCIENTIFIC NAME
Bermuda	Cynodon dactylon

ACCENTS	
COMMON NAME	SCIENTIFIC NAME
Agave	Agave americana
Paleleaf Yucca	Yucca pallida
Prickly Pear Cactus	Opuntia
Soft Leaf Yucca	Yucca recurvifolia
Texas Sotol	Dasylirion Texanum
Twisted Leaf Yucca	Yucca rupicola

SMALL SHRUBS	
COMMON NAME	SCIENTIFIC NAME
Artemisia*	Artemisia vulgaris*
Cherry Sage	Salvia greggii
Copper Canyon Daisy*	Tagetes lemmonii*
Dwarf Yaupon*	Ilex vomitoria 'Nana'
Foxtail Fern	Asparagus densiflorus
Red Yucca*	Hesperaloe parviflora*
Mexican Bush Sage	Salvia leucantha
Texas Betony*	Stachys coccinea*
Zexmenia	Wedelia acapulcensis var. hispida

GROUND COVER	
COMMON NAME	SCIENTIFIC NAME
Katie Dwarf Ruellia*	Ruellia brittoniana 'Katie'*
Pigeonberry*	Rivina humilis*
Silver Ponyfoot*	Dichondra argentea*
Trailing Lantana	Lantana montevidensis

\* Evergreen

† Designated option for use on Corner Lots and Amenity Lots for required "Continuous Hedge (Evergreen Screening Plants)".

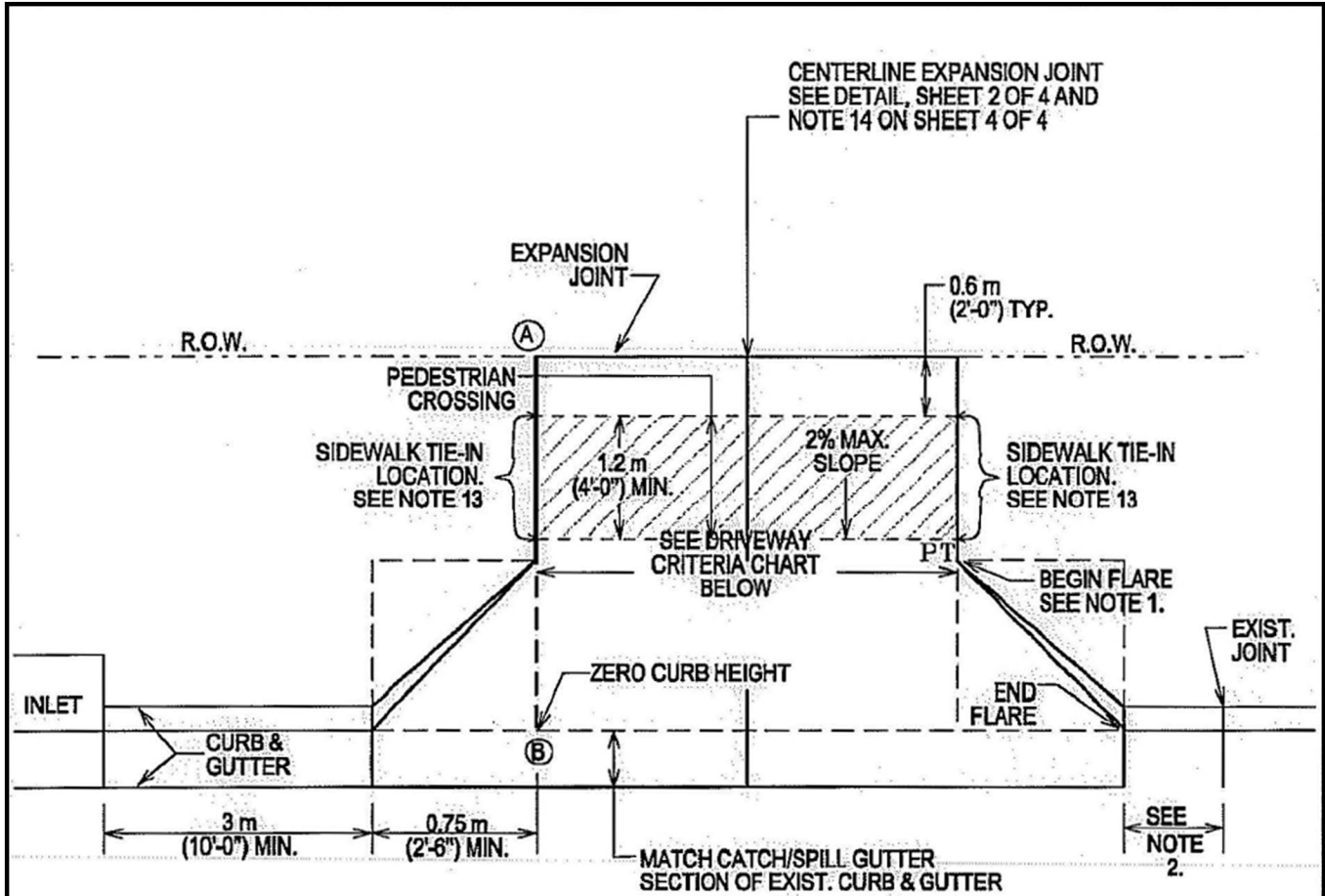

PLAN

NOTE: ALL DRIVEWAYS SHALL BE SLOPED TOWARDS THE STREET FROM THE R.O.W. LINE. ELEVATION OF POINT A ABOVE POINT B IS, TYPICALLY A MINIMUM OF 150 mm (6") PLUS 20 mm/m (1/4" RISE/FOOT) OVER DISTANCE \*X\* IN METERS (FEET).

DRIVEWAY CRITERIA	WIDTH METERS (FEET)		
	MIN.	*OPT.	MAX.
SINGLE FAMILY	3.66 (12)	5.50 (18)	11.80 (25)
DUPLEX	4.56 (15)	5.50 (18)	11.80 (25)
TOWN HOME	4.56 (15)	5.50 (18)	11.80 (25)

\*OPTIMUM

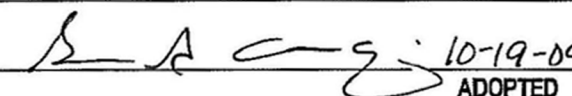
<b>CITY OF AUSTIN</b> DEPARTMENT OF PUBLIC WORKS	<b>FLARED TYPE I DRIVEWAY</b> (1 & 2 FAMILY RESIDENTIAL USE ONLY)	STANDARD NO. <b>433S-1A</b> 1 OF 4
 10-19-09 ADOPTED		THE ARCHITECT/ENGINEER ASSUMES RESPONSIBILITY FOR APPROPRIATE USE OF THIS STANDARD.

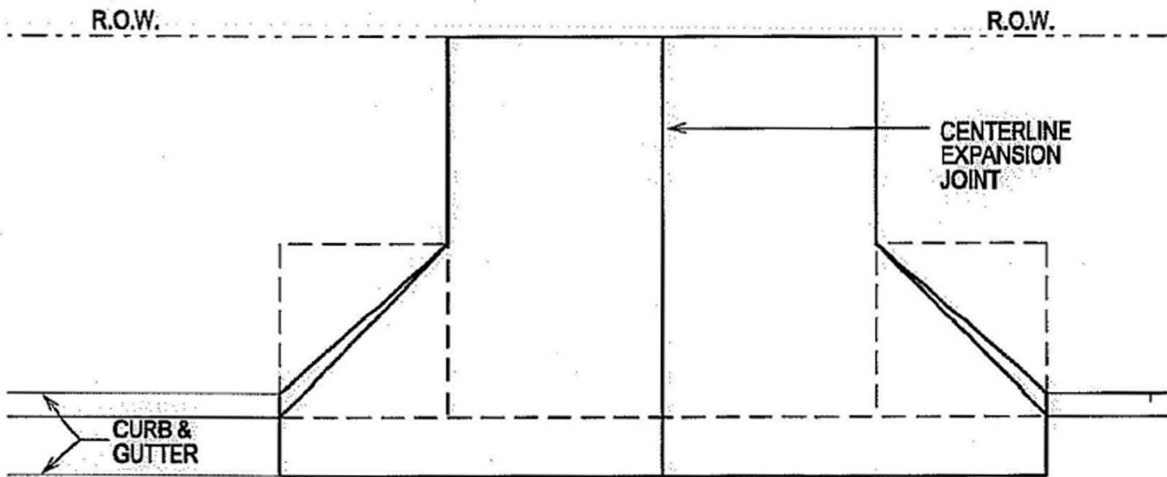

PLAN

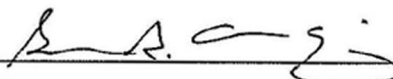
CITY OF AUSTIN DEPARTMENT OF PUBLIC WORKS	FLARED TYPE I DRIVEWAY (1 & 2 FAMILY RESIDENTIAL USE ONLY)	
 10-19-09 ADOPTED	THE ARCHITECT/ENGINEER ASSUMES RESPONSIBILITY FOR APPROPRIATE USE OF THIS STANDARD.	STANDARD NO. 433S-1A 2 OF 4

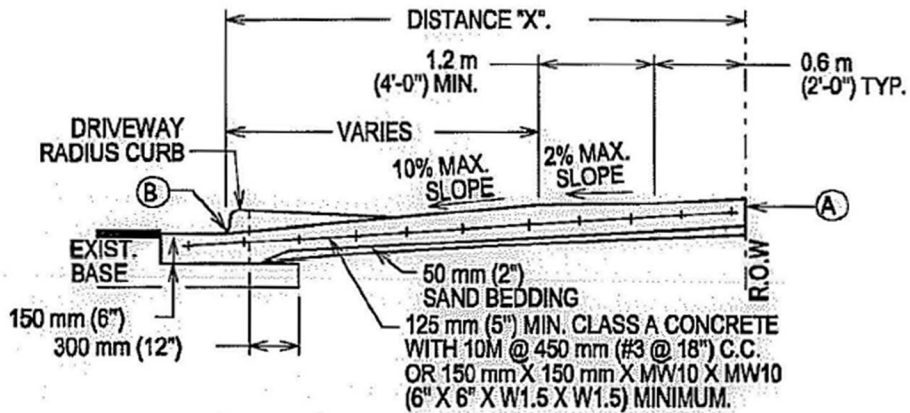

REINFORCEMENT SHALL ACCURATELY PLACED AT SLAB MID-DEPTH AND HELD FIRMLY IN PLACE BY MEANS OF BAR SUPPORTS OF ADEQUATE STRENGTH AND NUMBER THAT WILL PREVENT DISPLACEMENT AND KEEP THE STEEL AT ITS PROPER POSITION DURING THE PLACEMENT OF THE P.C. CONCRETE. IN NO INSTANCE SHALL THE STEEL BE PLACED DIRECTLY ON THE SUBGRADE OR SAND CUSHION LAYER.

**CROSS SECTION**

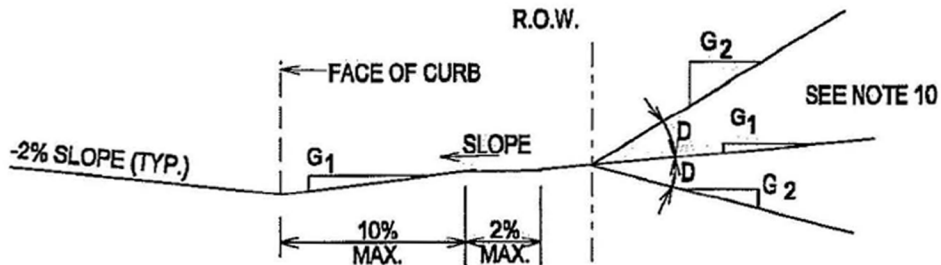

**ALLOWABLE GRADES**

<p>CITY OF AUSTIN DEPARTMENT OF PUBLIC WORKS</p>	<p>FLARED TYPE I DRIVEWAY (1 &amp; 2 FAMILY RESIDENTIAL USE ONLY)</p>	
<p><i>[Signature]</i> 10-19-09 ADOPTED</p>	<p>THE ARCHITECT/ENGINEER ASSUMES RESPONSIBILITY FOR APPROPRIATE USE OF THIS STANDARD.</p>	<p>STANDARD NO. <b>433S-1A</b> 3 OF 4</p>



**NOTES:**

1. "ZERO" CURB AT BEGINNING OF FLARE OR SIDEWALK EDGE, WHICHEVER IS ENCOUNTERED FIRST. THE DRIVEWAY EDGE SHALL BE SMOOTHLY TRANSITIONED INTO THE SIDEWALK BEGINNING AT THE END OF FLARE.
2. IF DIMENSION IS LESS THAN 1.5 METERS (5 FEET), REMOVE CURB AND GUTTER TO EXISTING JOINT AND POUR MONOLITHICALLY WITH THE DRIVEWAY.
3. IF THE BASE MATERIAL UNDER AND BEHIND THE CURB IS OVER-EXCAVATED WHERE THE CURB AND GUTTER WAS REMOVED, BACKFILL WITH CONCRETE MONOLITHICALLY WITH THE DRIVEWAY.
4. ALL DRIVEWAYS MUST BE CONSTRUCTED WITHIN THE STREET FRONTAGE OF THE SUBJECT PROPERTY AS DETERMINED BY EXTENDING THE SIDE PROPERTY LINES TO THE CURB.
5. DRIVEWAYS SHALL NOT EXCEED 70% OF A LOTS' STREET FRONTAGE.
6. TYPE I DRIVEWAYS ARE TO BE LOCATED NO CLOSER TO THE CORNER OF INTERSECTING RIGHTS-OF-WAY THAN 60% OF PARCEL FRONTAGE OR 15 METERS (50 FEET); WHICHEVER IS LESS.
7. DRIVEWAYS SHALL NOT BE CONSTRUCTED WITHIN THE CURB RETURN OF A STREET INTERSECTION.
8. SINGLE FAMILY LOTS LIMITED TO ONE DRIVEWAY EXCEPT FOR APPROVED SEMICIRCULAR DRIVES.
9. WHEN TWO DRIVEWAYS ARE USED (ONE PER UNIT; TWO MAXIMUM) FOR DUPLEXES AND TOWN HOMES, SINGLE FAMILY STANDARDS SHALL APPLY.
10. WHILE THE PROPERTY OWNER REMAINS RESPONSIBLE FOR GRADE BREAKS WITHIN PRIVATE PROPERTY, THE FIRE DEPARTMENT SHOULD BE CONSULTED WHERE THE DRIVEWAY IS ESSENTIAL TO EMERGENCY VEHICLE ACCESS AND "G2" IS GREATER THAN 15%. "G1" PLUS "D" SHOULD NOT EXCEED 15%.
11. SEE TRANSPORTATION MANUAL SECTION 5 FOR OTHER DRIVEWAY REQUIREMENTS.
12. USE 12 mm (½") ASPHALT BOARD, OR OTHER APPROVED MATERIAL, FOR CURB AND GUTTER EXPANSION JOINTS.
13. THE SIDEWALK, REGARDLESS OF ITS LOCATION WITH RESPECT TO THE CURB OR PROPERTY LINE, SHALL BE CONNECTED TO THE DRIVEWAY AT THESE LOCATIONS.
14. PLACE AN EXPANSION JOINT DOWN THE CENTER OF ALL DRIVEWAYS.
15. WATER METER BOXES AND WASTEWATER CLEAN OUTS ARE PROHIBITED FROM BEING LOCATED IN DRIVEWAY AREAS.

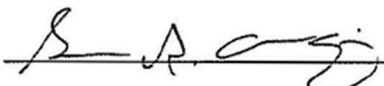
<p align="center"><b>CITY OF AUSTIN</b> DEPARTMENT OF PUBLIC WORKS</p>	<p align="center"><b>FLARED TYPE I DRIVEWAY</b> <b>(1 &amp; 2 FAMILY RESIDENTIAL USE ONLY)</b></p>	
 <p align="right">10-19-09 ADOPTED</p>	<p>THE ARCHITECT/ENGINEER ASSUMES RESPONSIBILITY FOR APPROPRIATE USE OF THIS STANDARD.</p>	<p align="center">STANDARD NO. <b>433S-1A</b> 4 OF 4</p>

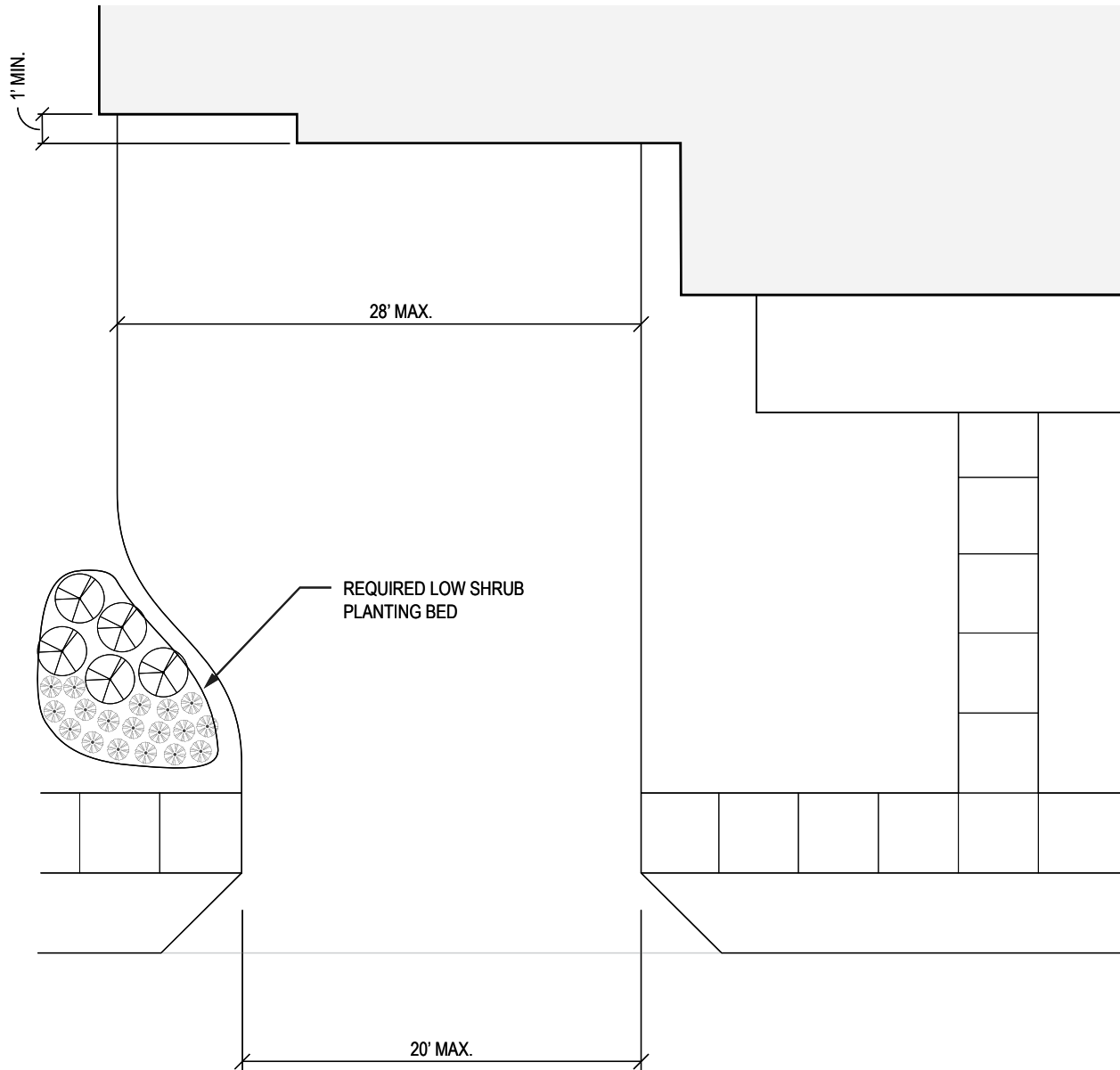

**NOTES**

1. A PLANTER BED WITH A MIX OF LOW SHRUBS MUST BE INSTALLED AND MAINTAINED AT THE PORTION OF THE DRIVEWAY WHERE THE TAPER OCCURS.
2. SPECIAL ATTENTION SHOULD BE GIVEN TO THIS PLANTER BED DESIGN AND ITS SHRUB HEIGHTS IN ORDER TO MAINTAIN A SAFE LINE-OF-SIGHT / ALLOW ADEQUATE VISIBILITY FROM MOTORISTS BACKING OUT OF THE DRIVEWAY TO ONCOMING TRAFFIC, CYCLISTS, AND PEDESTRIANS (ESPECIALLY CHILDREN).

**SAME PLAN / SAME ELEVATION**

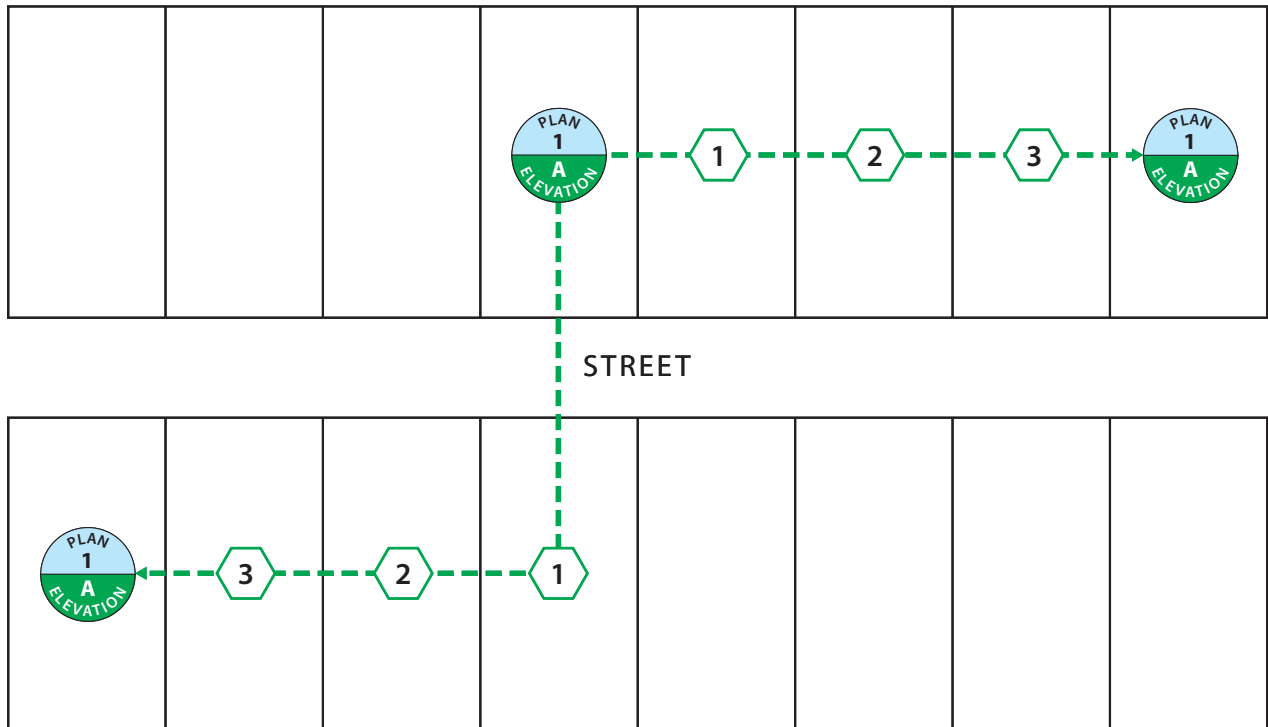

**SAME PLAN / DIFFERENT ELEVATION**

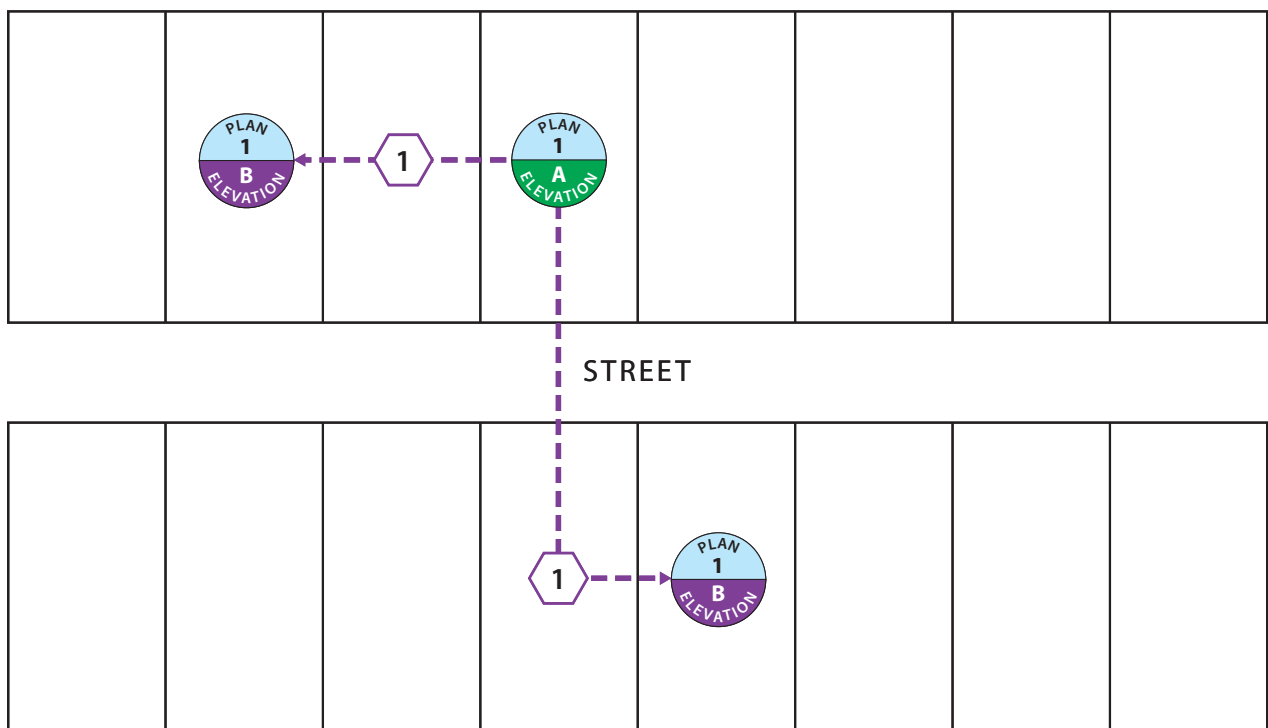

**VII. Supplemental Guidelines**

All supplemental guidelines will be found on the pages that follow.